

# PORTABLE POWER DISTRIBUTION UNITS AND ACCESSORIES



The indicated extracts out of standards are for your information but without any liability. In case of doubt please refer to the complete original standard or regulation. The quotations from standards are hints where to get additional information on a specific topic.

We reserve the right for technical changes. The information specifies the products but does not guarantee any properties.

For prices please refer to our current trade price list.

WALTHER-WERKE	1
<i>“Off-The-Shelf” Power Distribution</i> HEB & HEBE Series of Portable Power Distribution	2
<i>Custom Design Power Distribution for Specific Markets &amp; Application</i> Beverage & Food Processing, Wineries	3
Manufacturing/OEM, Factories & Plants and Construction Sites	4
Marinas/ Ship Building and Ship Repair	5
Entertainment, Convention Centers, Trade Shows, & Sporting Events	6
Emergency Services	7
Alternate Energy, Wind, Solar and Mining	8
Military and Satellite Communications	9
Portable Power Distribution with Transformers	10

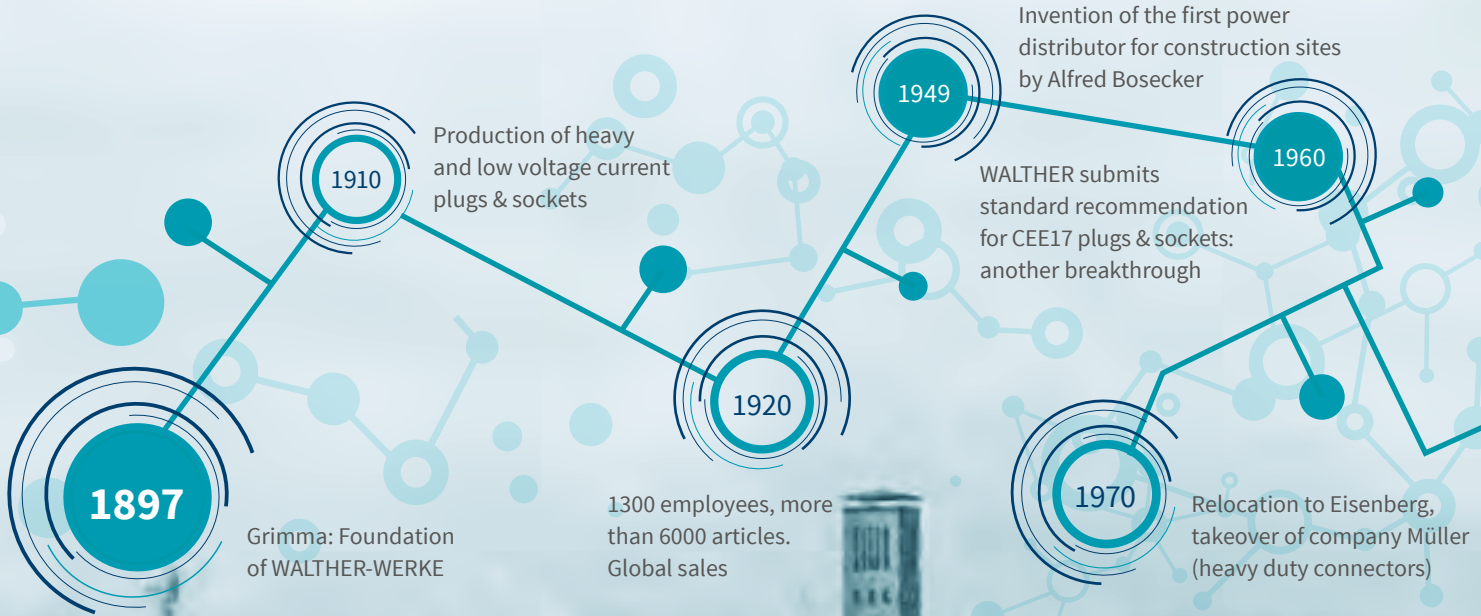

# WALTHER-WERKE A TRADITION OF ELECTRICAL ENGINEERING SINCE 1897

**1897** – Ferdinand Walther founds WALTHER-WERKE. Since this time, the world has changed dramatically. After the second and third industrial revolutions, we are now entering the fourth: Industry 4.0. In the world of work and in our everyday lives, far-reaching changes are on the way. During such dynamic times, reliable partners are needed who are working now to prepare for the future.

WALTHER-WERKE have over hundred and twenty years of experience and are the experts in low voltage distribution. Since it was first founded, the company has proven its excellence time and time again at providing products and solutions for present-day and future needs. Adaptation and innovation are therefore part of WALTHER's DNA. So it is no coincidence that key innovations, such as the construction site power distributor in the 1940s and the CEE type plug connector in the 1960s were inventions by WALTHER-WERKE.



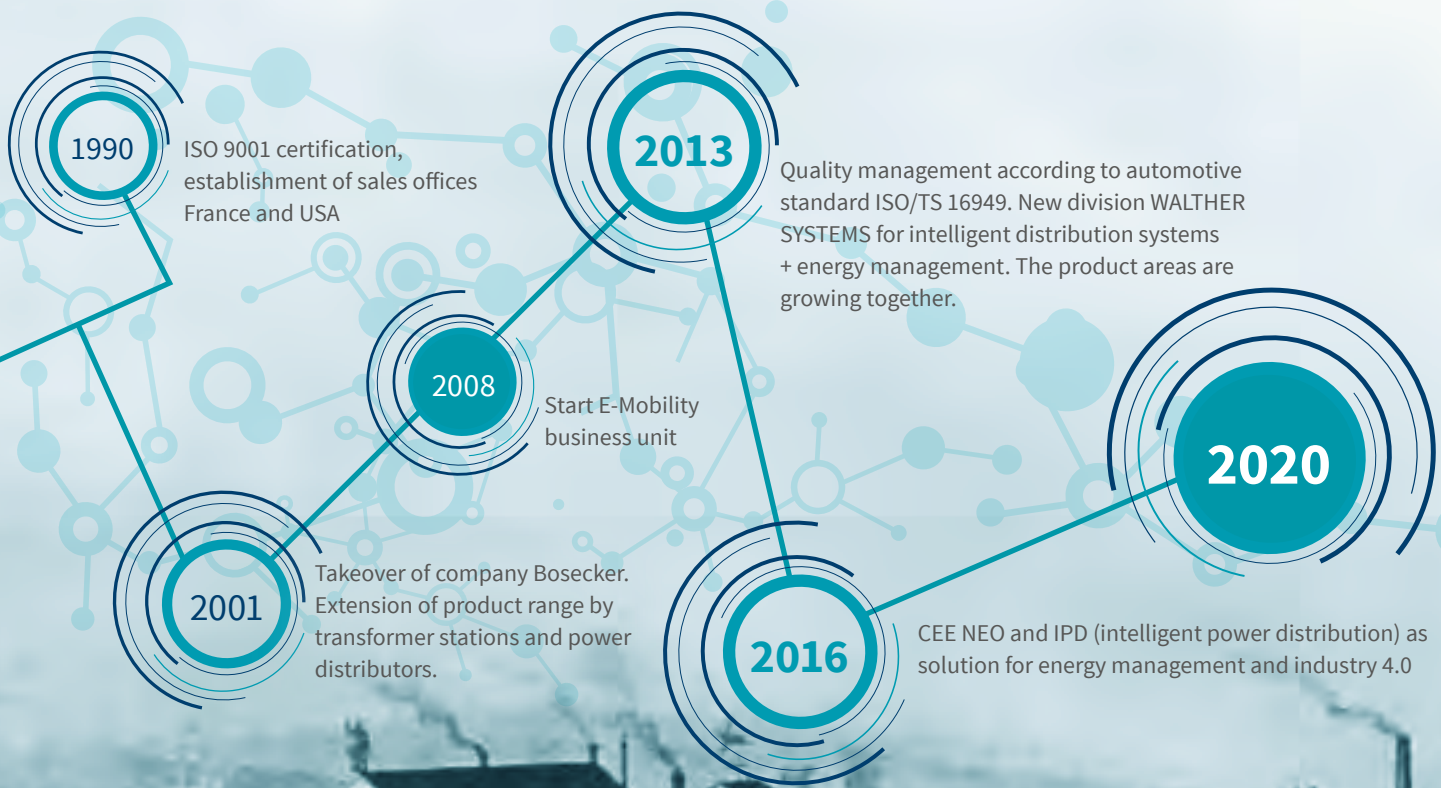

**Today**, the Group as a whole employs more than 400 people in the development, production and marketing of CEE type plug and socket connections, plug and socket combinations, industrial plug connectors, electromobility charging infrastructure, power distributors, and transformer stations.

As a company with a global presence, WALTHER-WERKE is represented with its products and services on all of the world's core markets. In addition to more than 60 independent sales partners, the WALTHER Group has fully-owned subsidiaries in the USA, the UK, France, and Austria. These are primarily represented on the markets with sales and in some cases production activities, with the aim of providing our customers and partners with the best possible service.

1
2
3
4
5
6
7
8
9
10

# EXPERTISE AND COMMITMENT

WALTHER-WERKE have traditionally had a high degree of vertical integration when it comes to production. This means that virtually all of the key products are manufactured at German production sites. This allows us to guarantee our customers maximum flexibility, quality and most importantly technological expertise. WALTHER can handle every kind of customer request. From the creation of product and functional requirements in consultation with our customers and the development, design and creation of tools to products validated by our own, in-house testing laboratory: All from a single source. Components that we do not make ourselves are obtained exclusively from renowned, high-quality manufacturers with whom we have long-standing partnerships. After all, these components end up in a WALTHER product – and so we bear the responsibility for our customers' satisfaction.

But we don't just work under our own roof. WALTHER-WERKE's tradition also includes assuming an honorary role when working and taking responsibility with associations, as well as national and international standardization committees. This means we are able to contribute our extensive product and system expertise to the standardization process and also to ensure the advice we give to our customers always reflects the most up-to-date information.





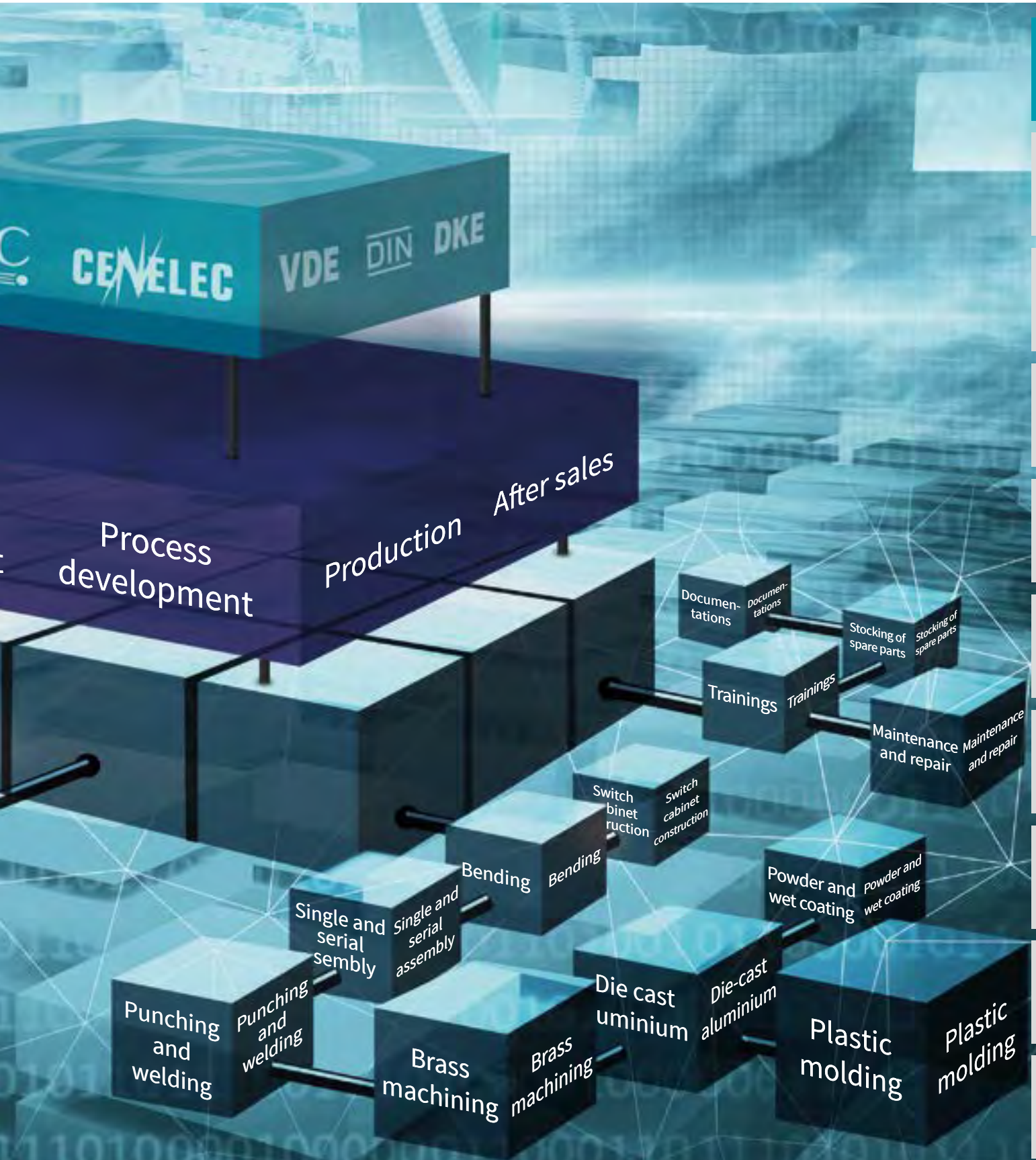

1
2
3
4
5
6
7
8
9
10







# INTEGRATED MANAGEMENT SYSTEMS ENSURE CUSTOMER-FOCUSED PROCESSES

Quality and quality management at WALTHER-WERKE means much more than mere product quality in the form of value and reliability. For us, quality management is an holistic management approach and is expressed in all of the company's activities.

By taking this approach, not only do we target quality assurance, but most importantly we aim to continuously improve all of our processes, regardless whether they are value-creating or supportive – and always with the goal of maximum customer satisfaction. Quality begins with the documentation of customers' and market needs and continues to include product development (FMEA, APQP etc.) through to the entire life cycle of our products. Processes must be measurable in terms of efficiency and effectiveness, and therefore steerable. For us, this comprehensive quality management forms the foundations of long-term, successful commercial relationships with our partners.

Our production has established a lean management system, the 'WALTHER-WERKE production system (PS)', declaring war on loss and waste.

Today we have a modern and regionally referenced production system which, through consistent shop floor management, represents all of the relevant performance indicators in a cascaded manner and optimizes them continuously through problem-solving methods in combination with a broad-based lean methods toolkit (SMED, One Piece Flow, Kanban, TPM, value stream design etc.) to benefit our customers. Skilled CIP teams work daily to improve our processes and integrate ideas from all employees regarding the best solutions. Lean management, and therefore ongoing continuous improvement (CIP), has therefore matured into part of the corporate culture nowadays at WALTHER.

1

2

3

4

5

6

7

8

9

10

# SALES: GLOBAL PRESENCE FOR MAXIMUM CLOSENESS TO THE CUSTOMER

Our slogan, “Your best connection” should be regarded not just as the overriding principle for the best connection technology, but also in particular counts as an incentive and inspiration in our interactions with customers to guarantee a reliable and trusting “connection” at all times. It is only through close communication with our customers that tailor-made solutions even become possible. A dense global sales network, comprising four of our own

subsidiaries and 60 international branches across all continents highlights our ambition to satisfy our customers’ wishes through expertise and closeness to the market. We are not interested in short-term successes, preferring instead partnerships of many years’ continuous standing that play a vital role in our customers’ strategic focus and which therefore represent an essential element of their added value process.



BOSECKER VERTEILERBAU SACHSEN GMBH,  
ZITTAU



WALTHER-WERKE FERDINAND WALTHER  
GMBH, WALTHER SYSTEMS, LEIPZIG

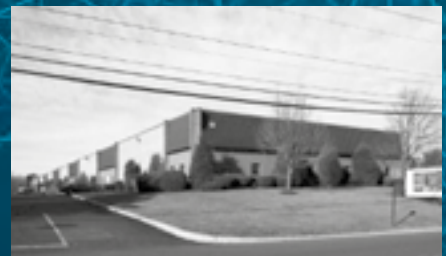

F. WALTHER ELECTRIC CORP,  
USA



We regard ourselves as the ideal partner to the electrical trade and as a systems supplier to the industry and construction sector. To ensure the availability of our products at all times, we also use the logistical opportunities made available to us by our electrical wholesale partners. The satisfaction of our customers lies at the heart of everything we do. Worldwide, with high-quality products and flawless service worthy of the label "Made in Germany".



WALTHER-WERKE, EISENBERG



F. WALTHER ELECTRICS LTD,  
UNITED KINGDOM



F. WALTHER SARL,  
FRANCE



WALTHER ELECTRIC GMBH,  
AUSTRIA

1

2

3

4

5

6

7

8

9

10



# WALTHER-WERKE – CREATING CONNECTIONS BETWEEN ELECTRICAL CONSUMERS, CUSTOMERS AND THE ENERGY SUPPLY NETWORK

We offer comprehensive solutions for power distribution from medium voltage upwards and bring these to the consumer. Whether it be construction cranes, electric cars, industrial systems or camper vans – with static and mobile transformer stations and switchgear, we transform or switch low voltage to a maximum of 400 V. The decentral distribution then takes place via a broad selection of very different primary, sub and terminal distributors for all kinds of temporary or static applications. The great thing about it is that the power distribution is scalable and can be expanded at any time to reflect the real energy demand.

The “handover point” to consumers takes the form of CEE type plug and socket connections, industrial plug connectors and charging connections for electromobility. These are “Made by WALTHER”. This means everything from a single source, and everything is linked; designed to offer the maximum service life, in even the harshest environmental conditions.

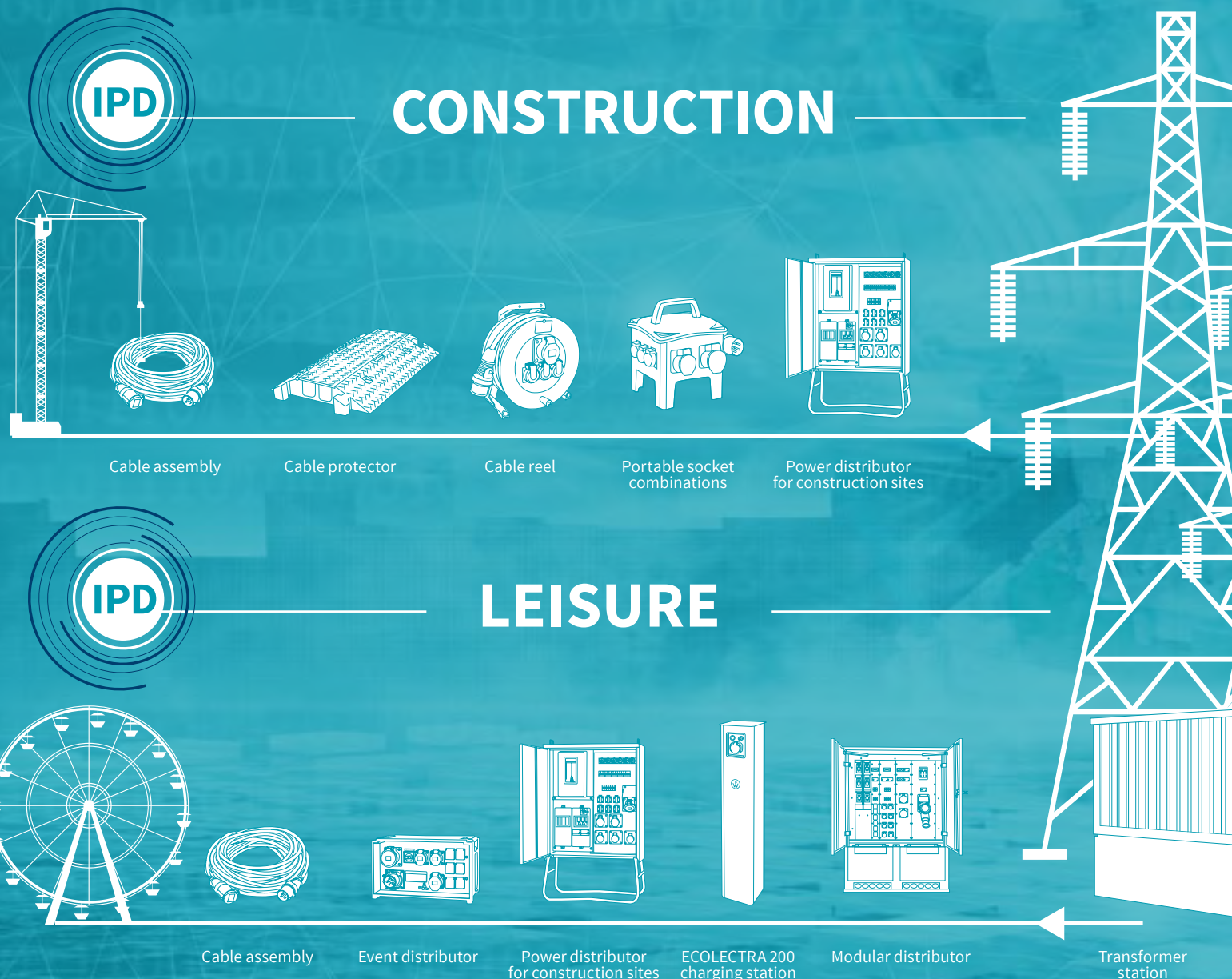

The unique breadth and depth of its product portfolio means that WALTHER-WERKE is able to design perfectly coordinated, comprehensive solutions and systems for its customers . The advantage for our customers most importantly lies in the fact that there is only one contact responsible for the entire project, with all of its overall system requirements.

This means that customers are spared the laborious task of compiling the individual components themselves. Even if the needs increase later or if there are other technical challenges, there is only ever one contact. Thanks to their system expertise, this contact will be able to offer effective and efficient solutions quickly.

1

2

3

4

5

6

7

8

9

10

## INDUSTRY

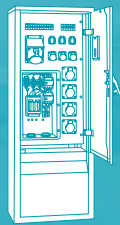

Industrial power distributor

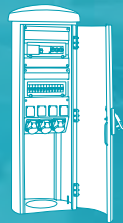

Bollard



Wall mount socket combination



Suspension-type socket combination



Cable assembly



## MOBILITY

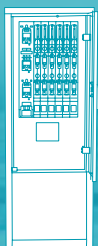

Cable distributor

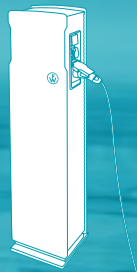

EVOLUTION 350 Charging station



EVOLUTION Wallbox



CUBE Pedelec charging cabinet



Charging cable



# POWER DISTRIBUTION UNITS, SYSTEMS & PANELS

## Standard Off-The-Shelf and Custom-Built

### Turn-key Solutions

**WALTHER ELECTRIC** welcomes the opportunity to supply off-the-shelf ready-made units; to manufacture custom power distribution units and power distribution systems; or to manufacture power panels that are built to your exact requirements. Our application engineers are ready to provide the necessary support and assistance needed during the technical specifications and design process.

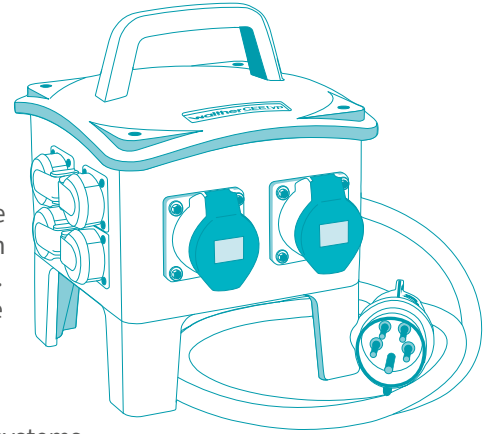

**WALTHER ELECTRIC** offers unique, custom-built power distribution units and systems, integrating multiple combinations of receptacles (output) plus the installation of a power inlet that combined in a single unit is industry referred to and identified as a “Combination Outlet.”

Combination outlets combine multiple like receptacles or an assortment of various different receptacles into one compact enclosure. By integrating numerous receptacles into one electrical enclosure, multiple conduit runs with individual branch circuit wiring can be eliminated. As a result, installation and material costs are significantly reduced. The combination outlets are shipped completely wired and ready to use. In most applications, our combination outlets will require only one connection to an incoming current supply to be ready for use.

**WALTHER** combination outlets can be constructed using IEC 60309 Pin & Sleeve devices, standard NEMA-type devices, CAM-style single-pin connectors, stage-pin (Bates) type connectors, or by using practically any other type of receptacle or outlet that meets your specific requirements.

Safety is also woven into each **WALTHER** combination outlet via overload protection typically with built-in circuit breakers. The breakers are easily accessible by opening the see-through side-entry cover/door. Additionally **WALTHER** combination outlet systems are available fused, with RCDs, GFCI breakers or with virtually any type of overload protection that meets your requirements. Each portable power distribution unit (PDU) is inspected and tested. A copy of the test results certificate is provided with the shipment of each unit. Additionally, the test data is archived and can be retrieved for future reference.

Think of “Combination Outlets” as being a heavy-duty, industrial-quality, breaker-protected, surge suppressor. **WALTHER Electric** is your total **Turn-key Solutions Provider**.

### If you can think it, we can build it!

Call or e-mail your requirements today!

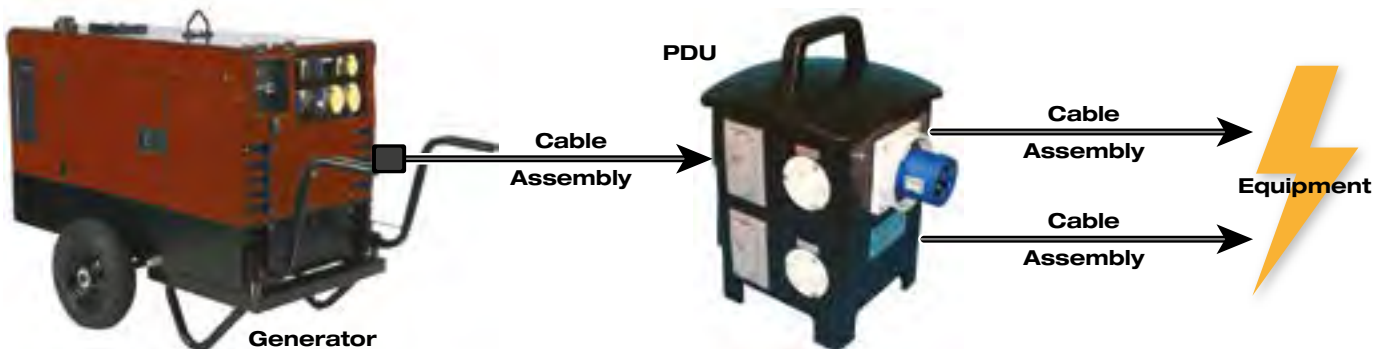



## The Who, What, Where, When and How of PDU's

The ancient adage of Who, What, Where, When and How seems to have been coined for WALTHER PDU/PDS products.

**Who** can use the WALTHER products and systems that are presented in this catalog? Most any company or organization that requires portable, safe-power distribution.

**What** specific industries or organizations have used WALTHER PDU/PDS systems? Those listed below are the most prominent types of user.

**Where** are the units used? Simply stated, virtually anywhere portable power is required indoors or outdoors, from heavy-duty dirty environments such as shipyards and construction sites to super clean locations such as hospitals and test & analysis laboratories.

**When** are they used? In some instances, when a temporary additional power source is needed such as at convention and exposition centers for trade show displays. Power sources are supplied for the displays, and at the conclusion of the shows, the power sources are removed with the PDUs stored until the next trade show. Our units also may be used as a permanent power source primarily where conduit/hard wiring is not possible.

**How** are the WALTHER PDU/PDS units used? They are really quite simple to use and setup requires little time. Start with a power source – such as a generator – connect the power cable from the generator to the PDU power inlet. The unit is now energized and ready for use.

All units have multiple receptacles that can be simultaneously used for different power needs. WALTHER PDU/PDS units have literally been used around the world including at several well known venues as at the Olympics, the Emmy's and several Super Bowl games.

### Common Users

- Exhibition & Convention Centers
- Shipyards – Dockside & Shipboard
- Cruise Ships
- Data Centers
- Entertainment / Concerts
- Orchestras & Musical Groups
- Military
- Nuclear Facilities
- Hotels & Casinos
- Airports
- Railroads & Mass Transit
- Sports Complexes
- Theme & Amusement Parks
- Fire Departments
- Municipalities
- Universities & Schools
- Hospitals
- Power Rental Companies
- Television & Stage
- Fairgrounds & Carnivals
- Industrial Plants
- Test & Analysis Labs
- Breweries
- Construction Job Sites



**Remember,  
if you can think it,  
we can build it!**



**HEB & HEBE Series of Portable Power Distribution**

**HEB201L**

PROTECTION:  
(6) 20A 1P MCB

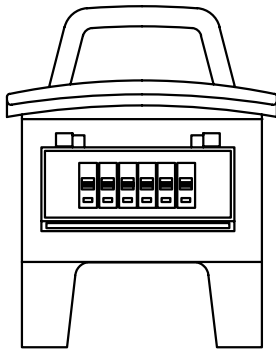

FRONT

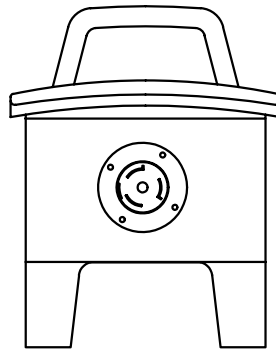

BACK

INPUT:  
50A INLET CS6375  
120/250V, 2P+N+G

OUTPUT:  
(3) 20A GFCI

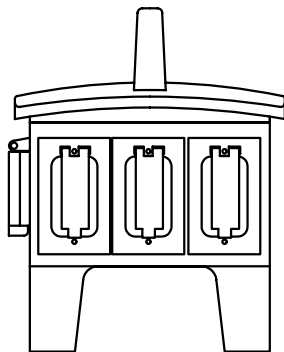

RIGHT

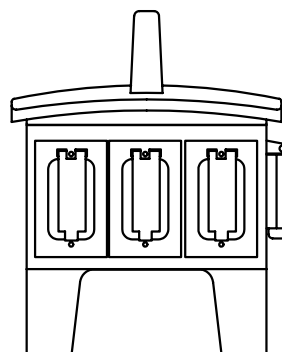

LEFT

OUTPUT:  
(3) 20A GFCI

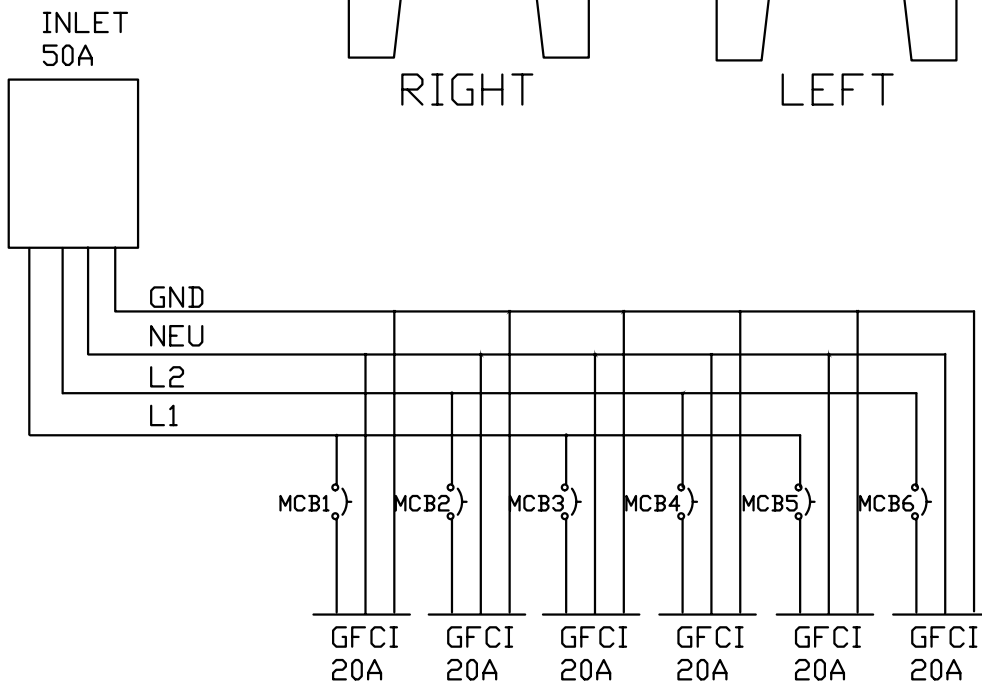

**HEB201L**

**50A, 1-PH, 2-Pole, 4-Wire, UL Listed**

**DESCRIPTION**

120/208VAC, Single Phase one tier PDU with Input: (1) 50A Twist lock, CS6375, 2-Pole, 4 Wire inlet, Output: (6) 20A Duplex GFCI receptacles with weather cover protected by (6) 20A 1-Pole circuit breakers

**SPECIFICATIONS**

RATING	50A, 120/208VAC, 2P+N+G
ENVIRONMENTAL RATING	NEMA 3R
INPUT	(1) 50A CS Type 2P+N+G
OUTPUT	(6) 20A Duplex GFCI
OVERCURRENT PROTECTION	(6) 20A 1-Pole, MCB
DIMENSIONS	L 11.5” W 12.5” H 14”
WEIGHT	19 lbs.



- 1
- 2
- 3
- 4
- 5
- 6
- 7
- 8
- 9
- 10



HEB & HEBE Series of Portable Power Distribution

**HEB201U**

PROTECTION:

- (1) 50A 2POLE MCB
- (6) 20A 1POLE MCB

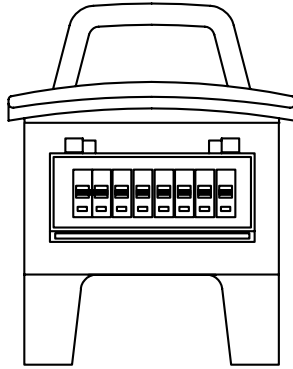

FRONT

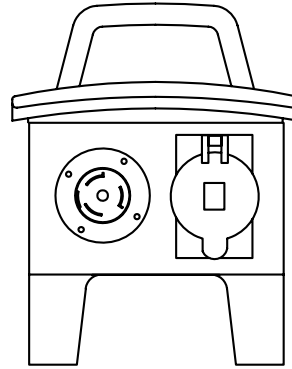

BACK

OUTPUT:  
(1) 50A CS6369  
W/W. COVER

INPUT:  
50A INLET CS6375  
120/250V, 2P+N+G

OUTPUT:  
(3) 20A GFCI  
W/W. COVER

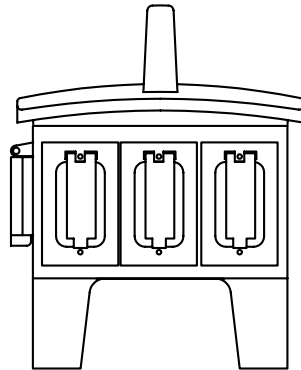

RIGHT

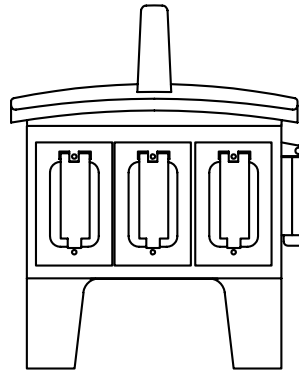

LEFT

OUTPUT:  
(3) 20A GFCI  
W/W. COVER

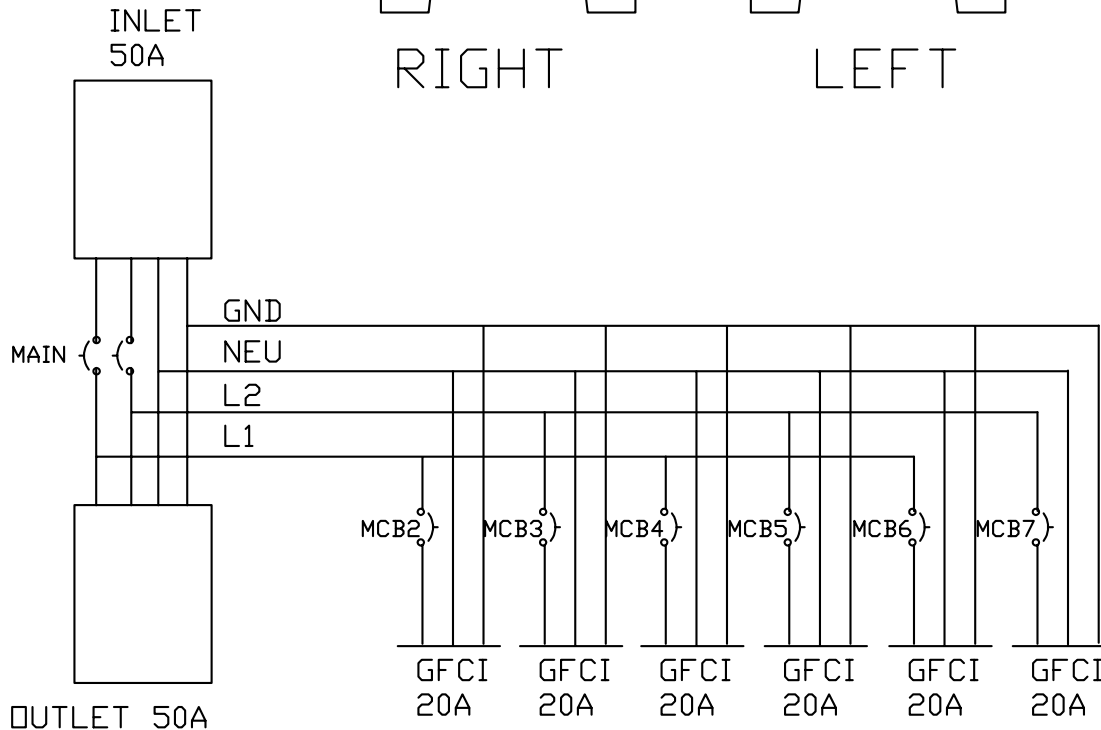

**HEB201U**

**50A, 1-PH, 2-Pole, 4 Wire, UL Listed**

**DESCRIPTION**

120/208VAC, Single Phase one tier PDU with Input: (1) 50A Twist lock CS6375 2-Pole, 4 Wire inlet, Output: (1) 50A Twist lock, CS6369, 2-Pole, 4 Wire receptacle with weather cover, (6) 20A Duplex GFCI receptacles protected by (1) 50A 2-Pole breaker (main), (6) 20A 1-Pole breakers

**SPECIFICATIONS**

RATING	50A, 120/208VAC, 2P+N+G
ENVIRONMENTAL RATING	NEMA 3R
INPUT	(1) 50A CS Type 2P+N+G Inlet
OUTPUT	(1) 50A CS Type 2P+N+G Rec. (6) 20A Duplex GFCI
OVERCURRENT PROTECTION	(1) 50A 2-Pole, MCB (Main) (6) 20A 1-Pole, MCB
DIMENSIONS	L 11.5” W 12.5” H 14”
WEIGHT	19 lbs.



1

2

3

4

5

6

7

8

9

10

**HEB & HEBE Series of Portable Power Distribution**

**HEB201X2U**

PROTECTION:  
(1) 50A 2P MCB  
(6) 20A 1P MCB

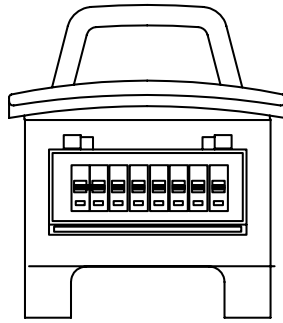

FRONT

INPUT:  
CS6375  
INLET

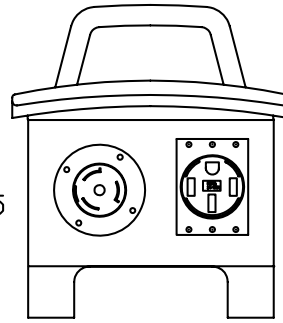

BACK

OUTPUT:  
(1) 50A 14-50R  
125/250V 2P+N+G

OUTPUT:  
(3) 20A DUPLEX

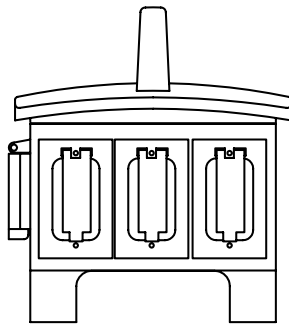

RIGHT

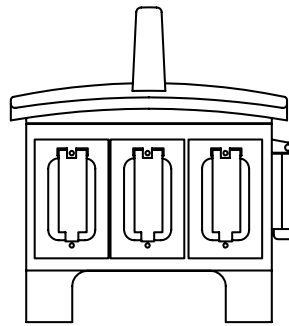

LEFT

OUTPUT:  
(3) 20A DUPLEX

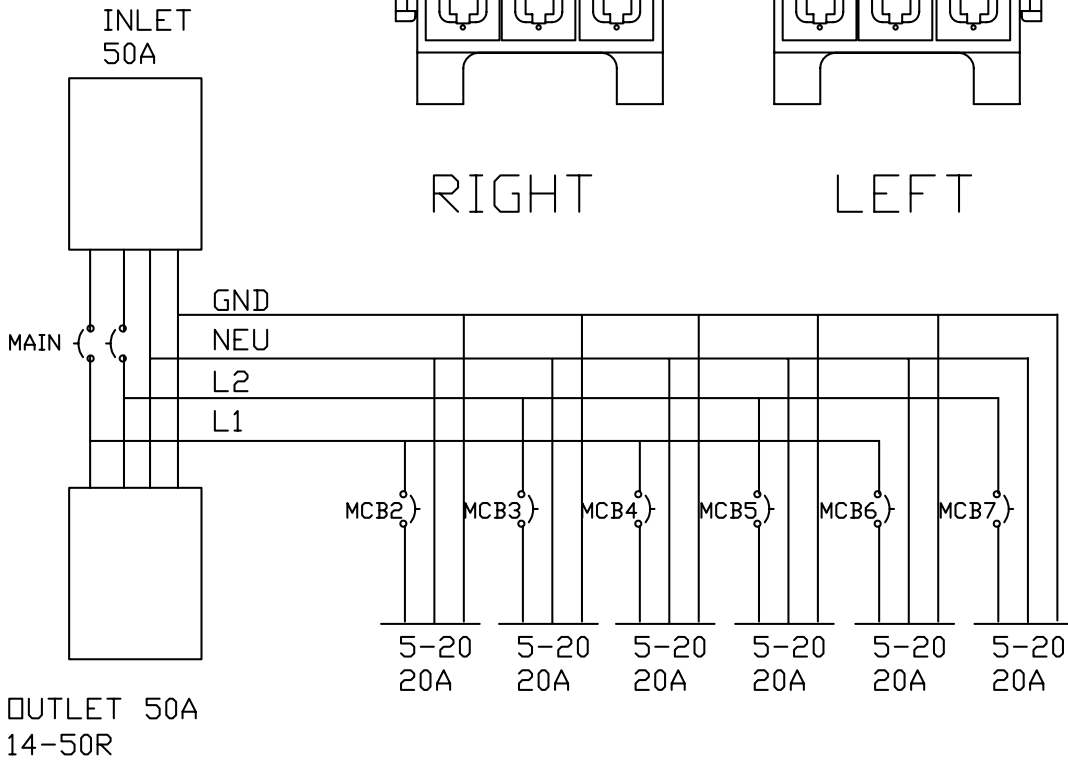



## HEB201X2U

### 50A, 1-PH, 2-Pole, 4-Wire, UL Listed

#### DESCRIPTION

120/208VAC, Single Phase one tier PDU with Input: (1) 50A Twist lock, CS6375, 2-Pole, 4 Wire inlet, Output: (1) 50A 14-50R, 2-Pole, 4 Wire Receptacle, (6) 20A NEMA 5-20R Duplex with weather cover receptacles protected by (1) 50A 2-Pole circuit breaker, (6) 20A 1-Pole circuit breakers

#### SPECIFICATIONS

RATING	50A, 120/208VAC, 2P+N+G
ENVIRONMENTAL RATING	Indoor use
INPUT	(1) 50A CS Type 2P+N+G Inlet
OUTPUT	(1) 50A 14-50R Receptacle (6) 20A 5-20R Duplex
OVERCURRENT PROTECTION	(1) 50A 2-Pole, MCB (Main) (6) 20A 1-Pole, MCB
DIMENSIONS	L 11.5” W 12.5” H 14”
WEIGHT	19 lbs.



1

2

3

4

5

6

7

8

9

10

**HEB & HEBE Series of Portable Power Distribution**

**HEB202U**

**PROTECTION:**

- (1) 50A 2P MCB
- (1) 30A 2P MCB
- (3) 20A 1P MCB

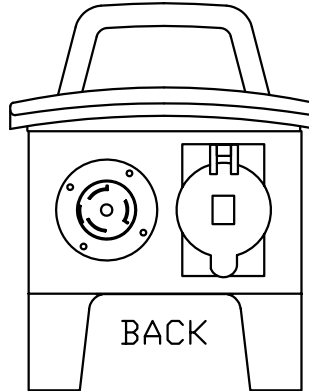
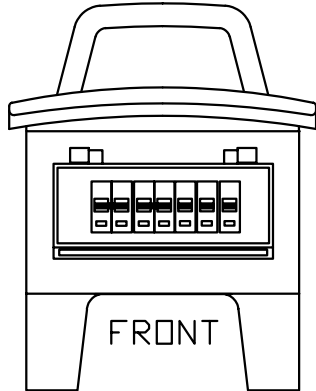

**INPUT:**  
CS6375 INLET  
250V 2P+N+G

**OUTPUT:**  
(1) 50A CS6369  
W/W. COVER

**OUTPUT:**

- (3) 20A GFCI  
W/W. COVERS

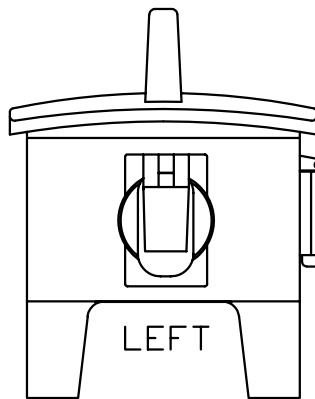
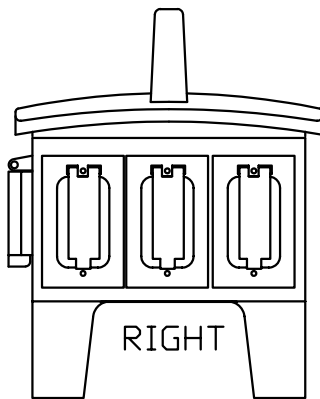

**OUTPUT:**  
(1) 30A L14-30  
W/W. COVER

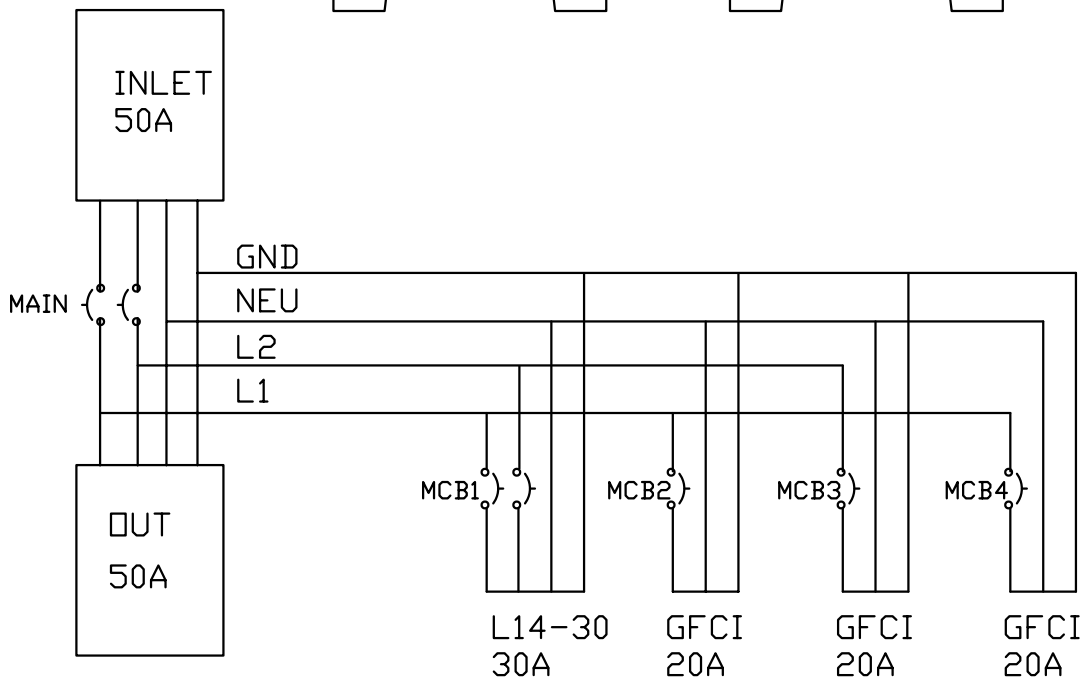

**HEB202U**

**50A, 1-PH, 2-Pole, 4-Wire, UL Listed**

**DESCRIPTION**

120/208VAC, Single Phase one tier PDU with Input: (1) 50A Twist lock, CS6375, 2-Pole, 4 Wire inlet, Output: (1) 50A Twist lock, CS6369 2-Pole, 4 Wire receptacle, (1) 30A Twist lock, L6-30R, 2-Pole, 3 Wire receptacles, (3) 20A Duplex GFCI receptacles protected by (1) 50A 2-Pole circuit breaker, (1) 30A 2-Pole circuit breakers, (3) 20A 1-Pole circuit breakers

**SPECIFICATIONS**

RATING	50A, 120/208VAC, 2P+N+G
ENVIRONMENTAL RATING	NEMA 3R
INPUT	(1) 50A CS Type, 2P+N+G Inlet
OUTPUT	(1) 50A CS Type, 2P+N+G Rec. (1) 30A L6-30R, 2P+G Rec. (3) 20A Duplex GFCI
OVERCURRENT PROTECTION	(1) 50A 2-Pole, MCB (Main) (1) 30A 2-Pole, MCB (3) 20A 1-Pole, MCB
DIMENSIONS	L 11.5” W 12.5” H 14”
WEIGHT	19 lbs.



1

2

3

4

5

6

7

8

9

10



HEB & HEBE Series of Portable Power Distribution

**HEB202UA**

PROTECTION:  
(1) 50A 2P MCB  
(1) 30A 2P MCB  
(3) 20A 1P MCB

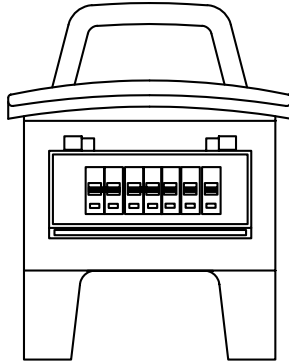

FRONT

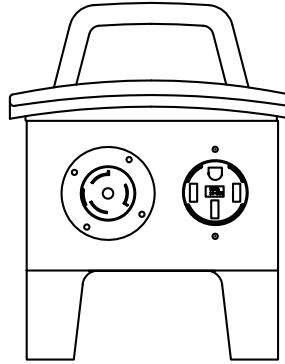

BACK

INPUT:  
50A INLET CS6375  
120/250V 2P+N+G

PASSTHRU:  
50A 14-50R  
120/250V 2P+N+G

OUTPUT:  
(3) 20A GFCI DPX

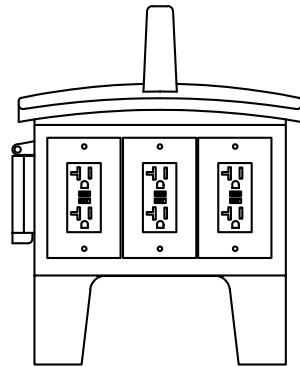

RIGHT

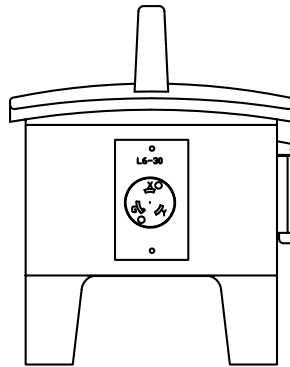

LEFT

OUTPUT:  
(1) 30A L6-30R

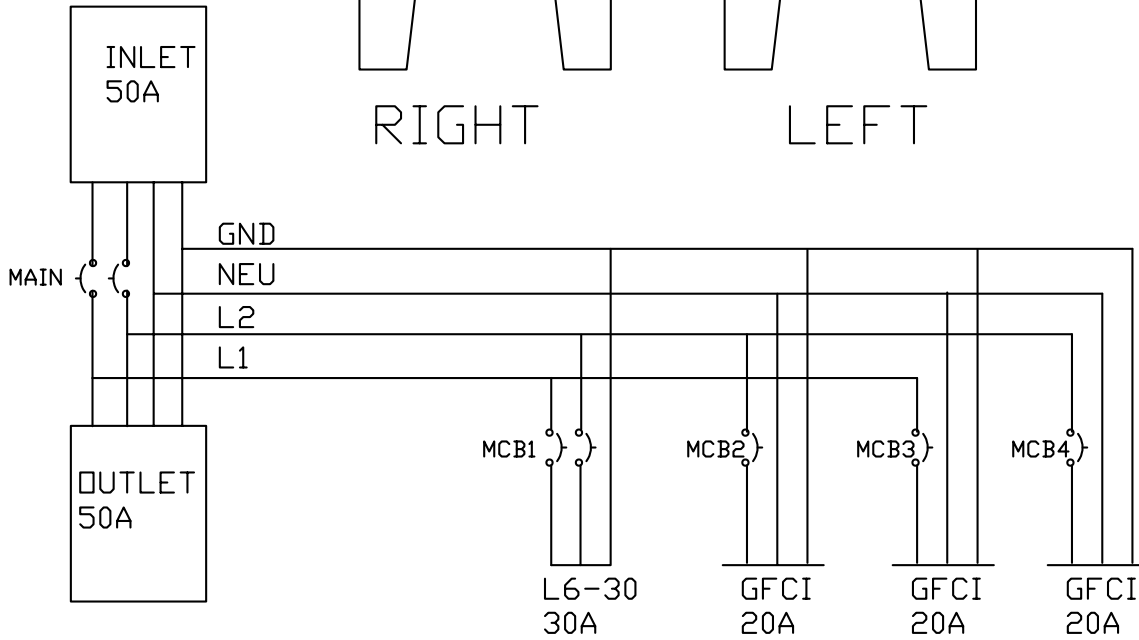

**HEB202UA**

**50A, 1-PH, 2-Pole, 4-Wire, UL Listed**

**DESCRIPTION**

120/208VAC, Single Phase one tier PDU with Input: (1) 50A Twist lock, CS6375, 2-Pole, 4 Wire inlet, Passthru: (1) 50A NEMA 14-50R, 2-Pole, 4 Wire receptacle, Output: (1) 30A Twist lock, L6-30R, 2-Pole, 3 Wire receptacle, (3) 20A, 5-20 Duplex GFCI receptacles protected by (1) 50A 2-Pole circuit breaker, (1) 30A 2-Pole circuit breakers, (3) 20A 1-Pole circuit breakers

**SPECIFICATIONS**

RATING	50A, 120/208VAC, 2P+N+G
ENVIRONMENTAL RATING	Indoor use
INPUT	(1) 50A CS Type, 2P+N+G Inlet
PASSTHRU	(1) 50a 14-50R 2P+N+G
OUTPUT	(1) 30A L6-20R, 2P+G Rec. (3) 20A 5-20 Duplex GFCI
OVERCURRENT PROTECTION	(1) 50A 2-Pole, MCB (Main) (2) 30A 2-Pole, MCB (3) 20A 1-Pole, MCB
DIMENSIONS	L 11.5” W 12.5” H 14”
WEIGHT	18 lbs.



1

2

3

4

5

6

7

8

9

10

**HEB & HEBE Series of Portable Power Distribution**

**HEB203U**

PROTECTION:

- (1) 50A 2P MCB
- (2) 30A 2P MCB
- (3) 20A 1P MCB

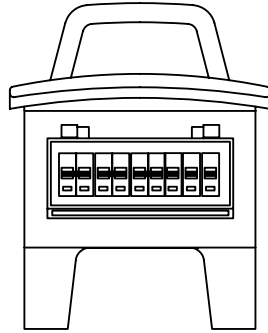

FRONT

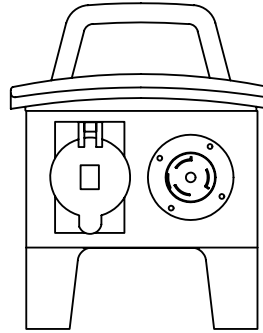

BACK

OUTPUT:  
(1) 50A CS6369  
W/W. COVER

INPUT:  
50A INLET CS6375  
120/250V, 2P+N+G

OUTPUT:

- (3) 20A DUPLEX GFCI

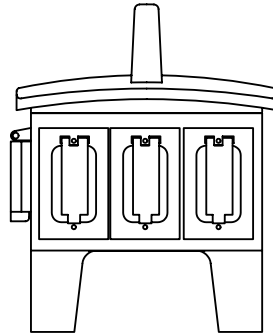

RIGHT

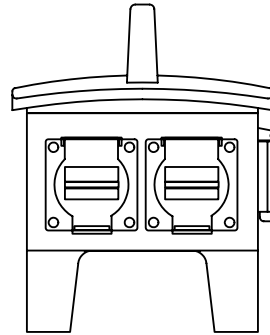

LEFT

OUTPUT:  
(2) 30A L6-30R

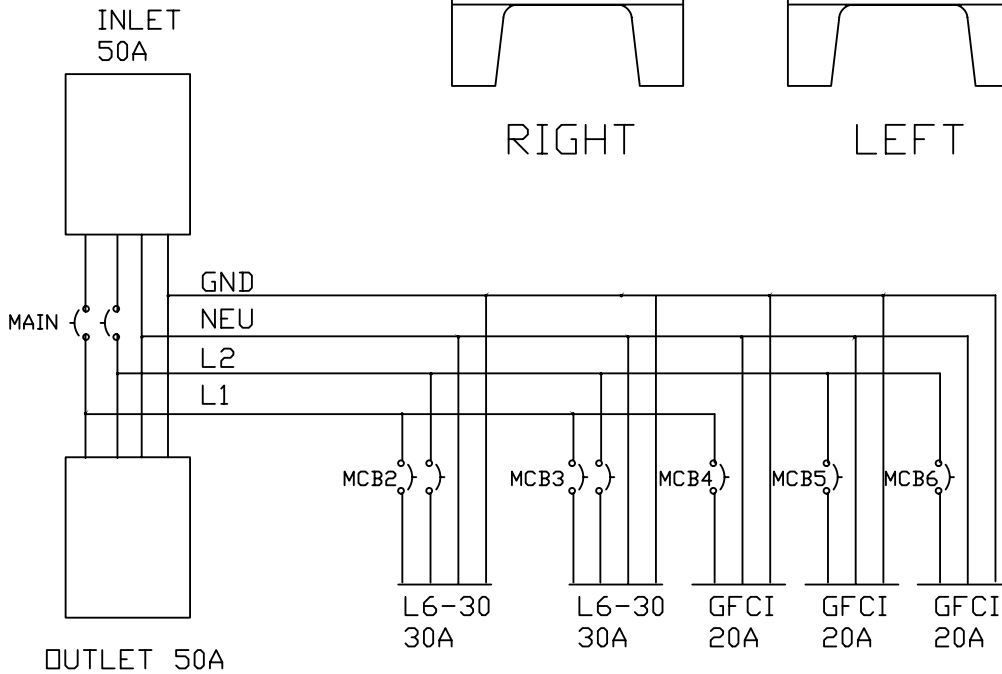

OUTLET 50A

**HEB203U**

**50A, 1-PH, 2-Pole, 4-Wire, UL Listed**

**DESCRIPTION**

120/208VAC, Single Phase one tier PDU with Input: (1) 50A Twist lock, CS6375, 2-Pole, 4 Wire inlet, Output: (1) 50A Twist lock, CS6369 2-Pole, 4 Wire receptacle, (2) 30A Twist lock, L6-30R, 2-Pole, 3 Wire receptacles, (3) 20A Duplex GFCI receptacles protected by (1) 50A 2-Pole circuit breaker, (2) 30A 2-Pole circuit breakers, (3) 20A 1-Pole circuit breakers

**SPECIFICATIONS**

RATING	50A, 120/208VAC, 2P+N+G
ENVIRONMENTAL RATING	NEMA 3R
INPUT	(1) 50A CS Type, 2P+N+G Inlet
OUTPUT	(1) 50A CS Type, 2P+N+G Rec. (2) 30A L6-30R, 2P+G Rec. (3) 20A Duplex GFCI
OVERCURRENT PROTECTION	(1) 50A 2-Pole, MCB (Main) (2) 30A 2-Pole, MCB (3) 20A 1-Pole, MCB
DIMENSIONS	L 11.5” W 12.5” H 14”
WEIGHT	19 lbs.



1

2

3

4

5

6

7

8

9

10



HEB & HEBE Series of Portable Power Distribution

**HEB361U**

PROTECTION:  
(6) 20A, 1POLE  
C CURVE MCB

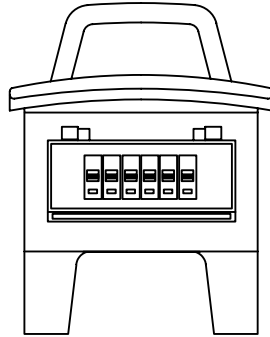

FRONT

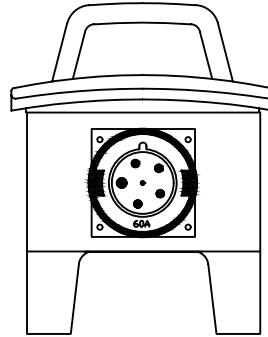

BACK

INPUT:  
60A IEC 3P+N+G  
120/250V

OUTPUT:  
(3) 20A DUPLEX

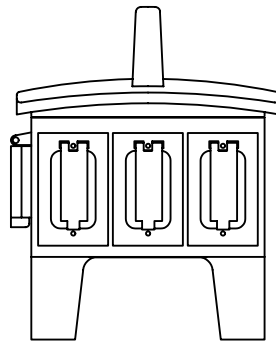

RIGHT

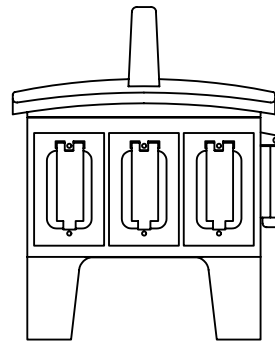

LEFT

OUTPUT:  
(3) 20A DUPLEX

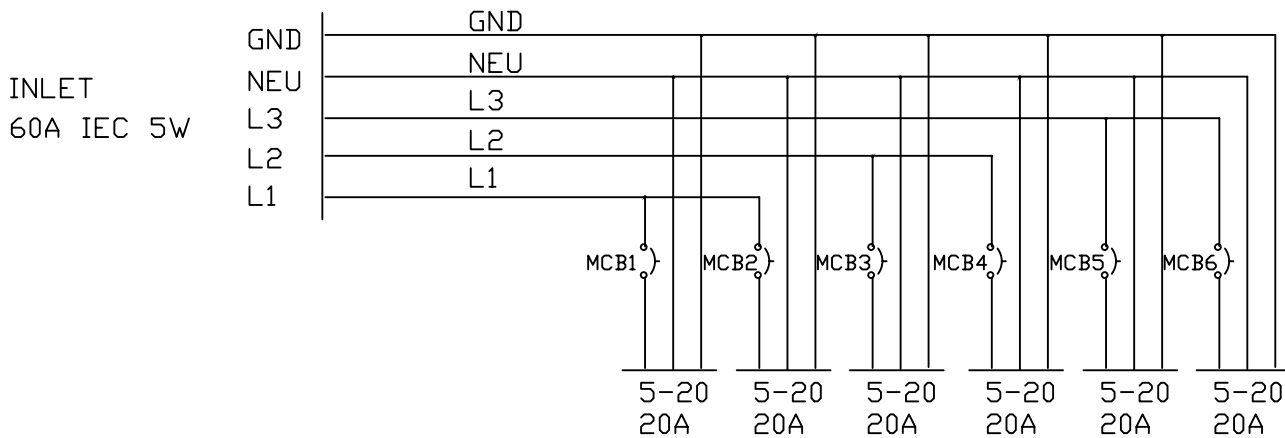

## HEB361U

### 40A, 3-PH, 3-Pole, 5-Wire, UL Listed

#### DESCRIPTION

120/208VAC, Three Phase one tier PDU with Input: (1) 60A IEC60309 IP67, 3-Pole, 5 Wire inlet, Output: (6) 20A NEMA 5-20 Duplex receptacles with weather cover protected by (6) 20A 1-Pole circuit breakers

#### SPECIFICATIONS

RATING	40A, 120/208VAC, 3P+N+G
ENVIRONMENTAL RATING	NEMA 3R
INPUT	(1) 60A IEC60309 IP67, 3P+N+G Inlet
OUTPUT	(6) 20A 5-20R Duplex Rec.
OVERCURRENT PROTECTION	(6) 20A 1-Pole, MCB
DIMENSIONS	L 11.5” W 12.5” H 14”
WEIGHT	19 lbs.



1

2

3

4

5

6

7

8

9

10

**HEB & HEBE Series of Portable Power Distribution**

**HEB363SCU**

PROTECTION:

- <2> 30A. 3 POLE, MCB
- <2> 20A. 1 POLE, MCB

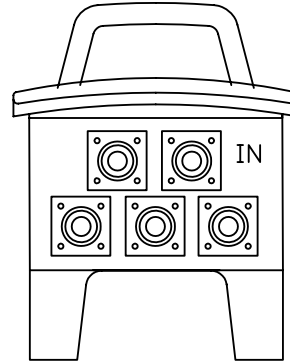
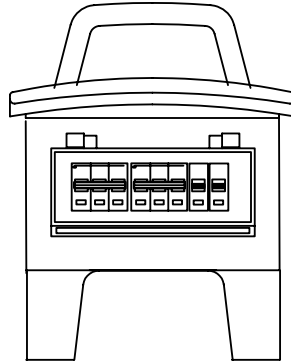

INPUT:

- <5> E16 CAMLOCKS
- 120/208V, 3P+N+G

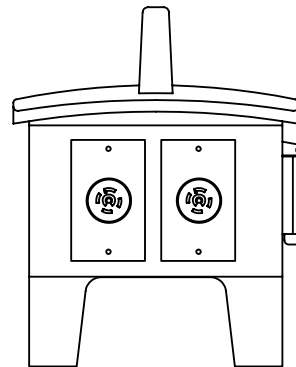
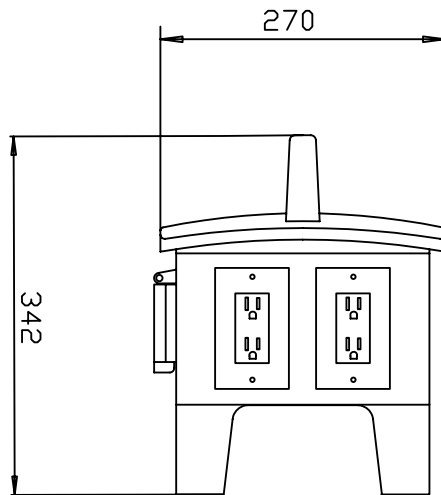

OUTPUT:

- <2> 20A DUPLEX

OUTPUT:

- <2> 30A L21-30R



**HEB363SCU**

**80A, 3-PH, 3-Pole, 5-Wire, UL Listed**

**DESCRIPTION**

120/208VAC, Three Phase single tier PDU with Input: (5) E16 Camlocks, 3-Pole, 5 Wire, Output: (2) 30A Twist lock, NEMA L21-30R, 3-Pole, 5 Wire receptacles, (2) 20A 5-20, Duplex receptacles protected by (2) 30A 3-Pole circuit breakers, (2) 20A 1-Pole circuit breakers

**SPECIFICATIONS**

RATING	80A, 120/208VAC, 3P+N+G
ENVIRONMENTAL RATING	Indoor use
INPUT	(5) E16 Camlocks, 3P+N+G
OUTPUT	(2) 30A L21-30R, 3P+N+G Rec. (2) 20A 5-20 Duplex Rec.
OVERCURRENT PROTECTION	(2) 30A 3-Pole, MCB (2) 20A 1-Pole, MCB
DIMENSIONS	L 11.5” W 12.5” H 14”
WEIGHT	19 lbs.



- 1
- 2
- 3
- 4
- 5
- 6
- 7
- 8
- 9
- 10

HEB & HEBE Series of Portable Power Distribution

**HEB1101**

PROTECTION:  
(6) 20A 1POLE MCB

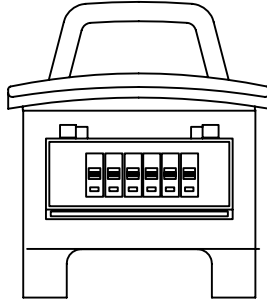

FRONT

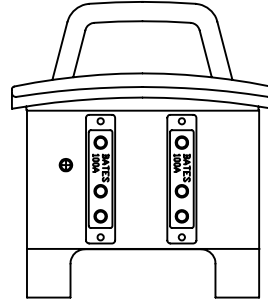

BACK

OUTPUT:  
(1) 100A STAGE PIN

INPUT:  
100A INLET STAGE PIN  
120V, 1P+N+G

OUTPUT:  
(3) 20A DUPLEX  
W/W. COVER

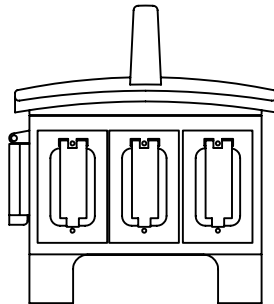

RIGHT

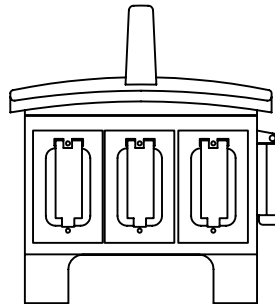

LEFT

OUTPUT:  
(3) 20A DUPLEX  
W/W. COVER

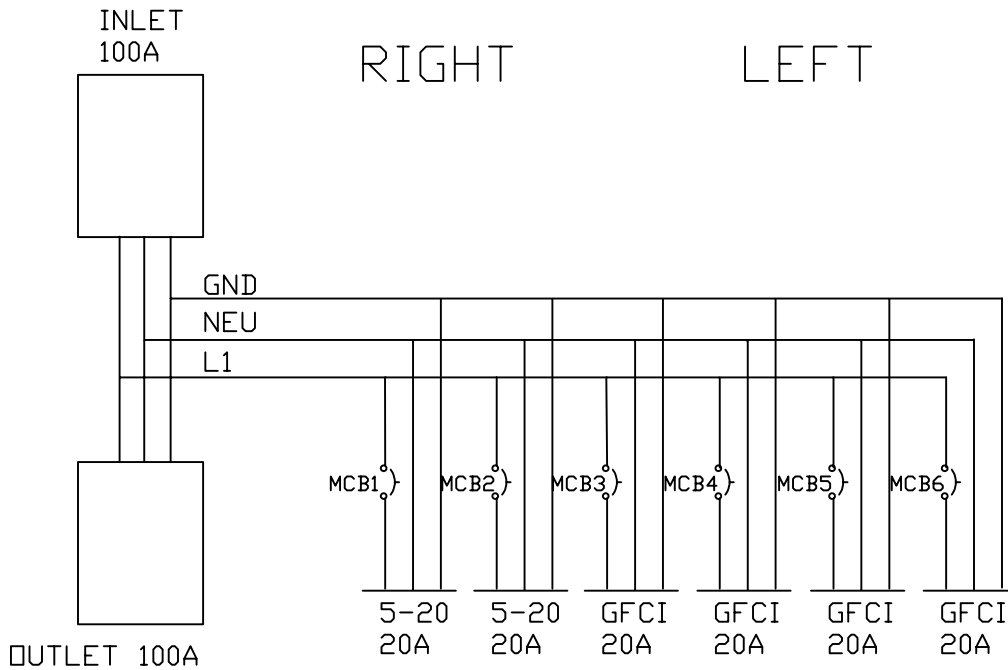

**HEB1101**

**100A, 1-PH, 1-Pole, 3-Wire, UL Listed**

**DESCRIPTION**

120 VAC, Single Phase one tier PDU with Input: (1) 100A Stage pin, 1-Pole, 3 Wire inlet, Pass thru: (1) 100A Stage pin, 1-Pole, 3 Wire receptacle, Output: (6) 20A NEMA 5-20R Duplex receptacles protected by (6) 20A 1-Pole circuit breakers

**SPECIFICATIONS**

RATING	100A, 120VAC, 1P+N+G
ENVIRONMENTAL RATING	Indoor use
INPUT	(1) 100A Stage pin, 1P+N+G Inlet
PASS THRU	(1) 100A Stage Pin, 1P+N+G Receptacle
OUTPUT	(6) 20A 5-20R Duplex
OVERCURRENT PROTECTION	(6) 20A 1-Pole, MCB
DIMENSIONS	L 11” W 12” H 14”
WEIGHT	18 lbs.



1

2

3

4

5

6

7

8

9

10



**HEB & HEBE Series of Portable Power Distribution**

**HEB3102AU**

PROTECTION:  
(6) 20A, 1POLE MCB

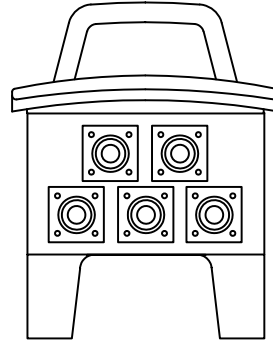
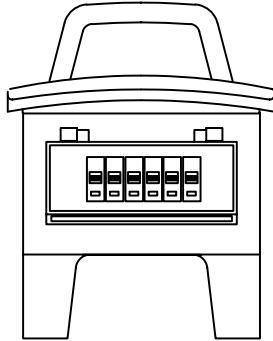

INPUT:  
(5) E16 CAMLOCKS  
120/208V 3P+N+G

OUTPUT:  
(3) 20A GFCI  
W/W COVER

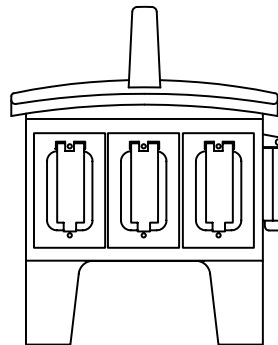
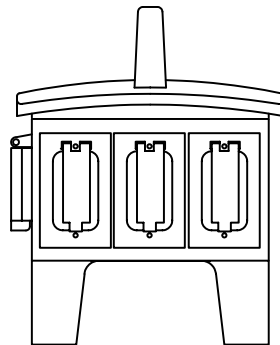

OUTPUT:  
(3) 20A GFCI  
W/W COVER

INLET  
(5) CAMLOCKS

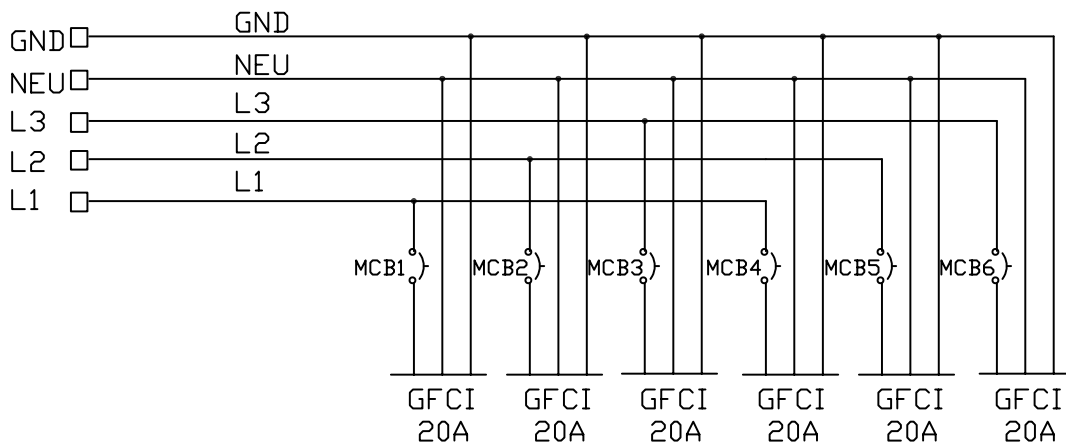

## HEB3102AU

### 40A, 3-PH, 3-Pole, 5-Wire, UL Listed

#### DESCRIPTION

120/208VAC, Three Phase one tier PDU with Input: (5) E16 Camlocks, 3-Pole, 5 Wire, Output: (6) 20A NEMA 5-20 Duplex receptacles with weather cover protected by (6) 20A 1-Pole circuit breakers

#### SPECIFICATIONS

RATING	40A, 120/208VAC, 3P+N+G
ENVIRONMENTAL RATING	NEMA 3R
INPUT	(5) E16 Camlocks, 3P+N+G
OUTPUT	(6) 20A 5-20R Duplex Rec.
OVERCURRENT PROTECTION	(6) 20A 1-Pole, MCB
DIMENSIONS	L 11.5” W 12.5” H 14”
WEIGHT	19 lbs.



1

2

3

4

5

6

7

8

9

10

**HEB & HEBE Series of Portable Power Distribution**

**HEB3102U**

PROTECTION:  
(6) 20A, 1POLE MCB

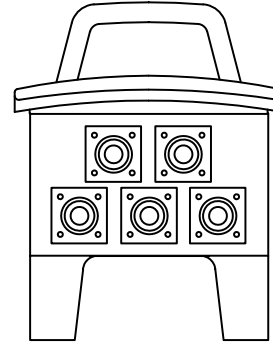
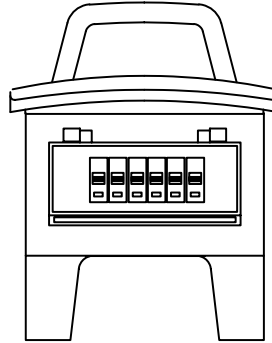

INPUT:  
(5) E16 CAMLOKS  
120/208V 3P+N+G

OUTPUT:  
(3) 20A GFCI  
W/W COVER

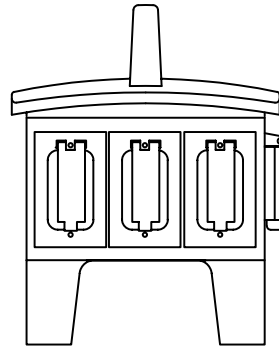
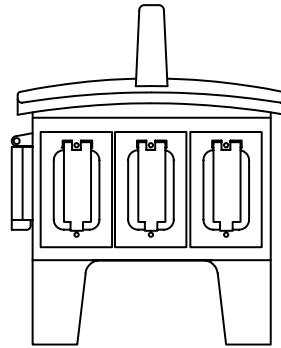

OUTPUT:  
(3) 20A GFCI  
W/W COVER

INLET  
(5) CAMLOKS

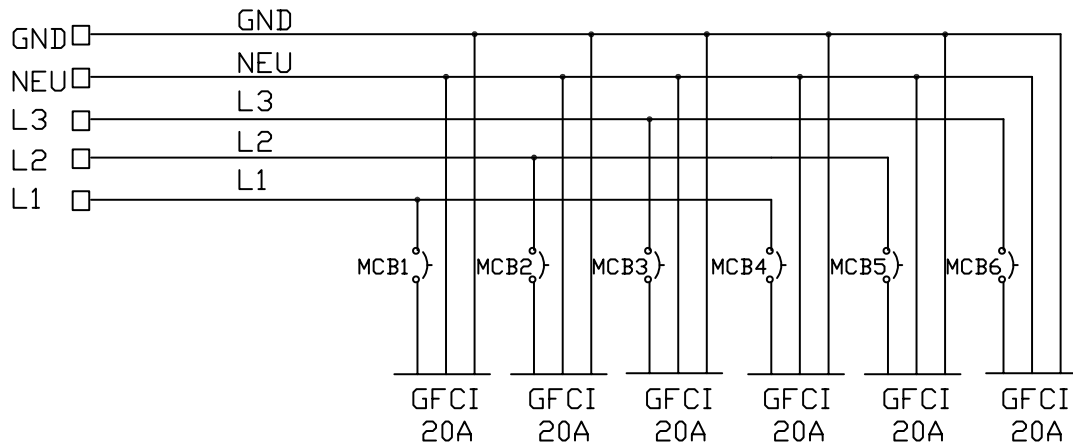



## HEB3102U

### 40A, 3-PH, 3-Pole, 5-Wire, UL Listed

#### DESCRIPTION

120/208VAC, Three Phase one tier PDU with Input: (5) E16 Camlocks, 3-Pole, 5 Wire, Output: (6) 20A Duplex GFCI receptacles with weather cover protected by (6) 20A 1-Pole circuit breakers

#### SPECIFICATIONS

RATING	40A, 120/208VAC, 3P+N+G
ENVIRONMENTAL RATING	NEMA 3R
INPUT	(5) E16 Camlocks, 3P+N+G
OUTPUT	(6) 20A Duplex GFCI Rec.
OVERCURRENT PROTECTION	(6) 20A 1-Pole, MCB
DIMENSIONS	L 11” W 12” H 14”
WEIGHT	19 lbs.



1

2

3

4

5

6

7

8

9

10

**HEB & HEBE Series of Portable Power Distribution**

**HEB3103U**

**PROTECTION:**

- (2) 30A 3P MCB
- (3) 20A 1P MCB

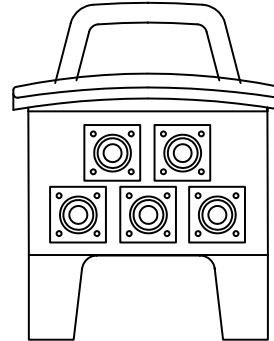
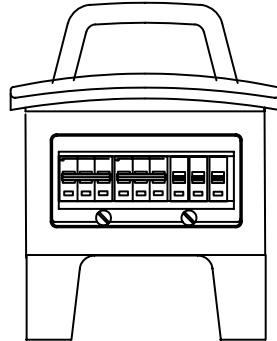

**INPUT:**

- (5) E16 CAMLOCKS
- 120/208V, 3P+N+G

**OUTPUT:**

- (3) 20A DUPLEX 5-20

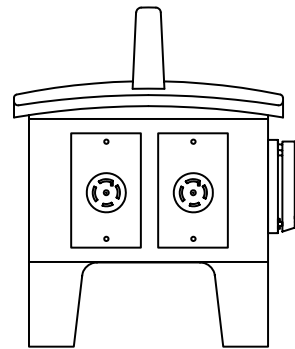
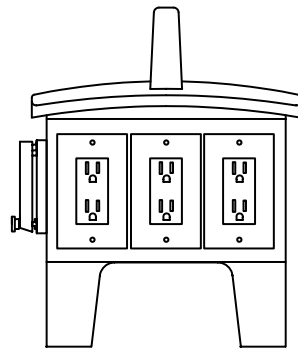

**OUTPUT:**

- (2) 30A L21-30R

**INLET**

- (5) CAMLOCKS

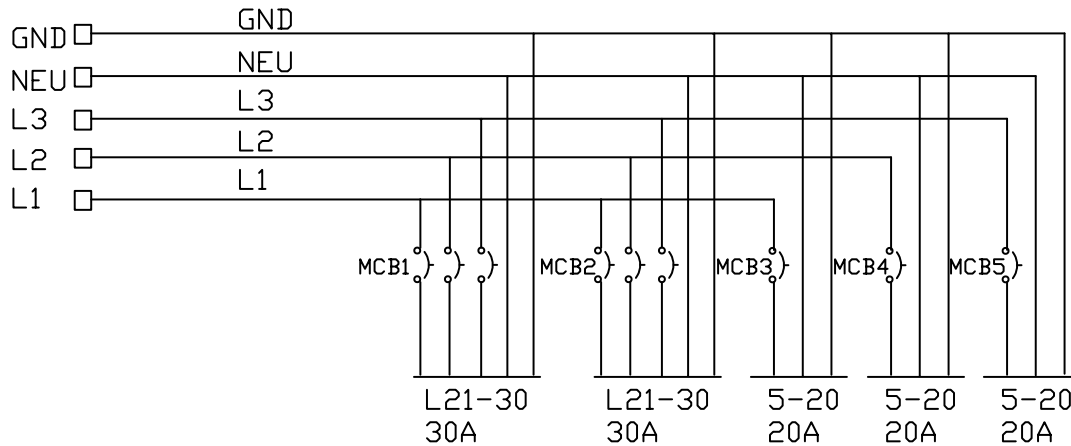

**HEB3103U**

**80A, 3-PH, 3-Pole, 5-Wire, UL Listed**

**Description**

120/208VAC, Three Phase one tier PDU with Input: (5) E16 Camlocks, 3-Pole, 5 Wire, Output: (2) 30A Twist lock, NEMA L21-30R, 3-Pole, 5 Wire receptacles, (3) 20A 5-20 Duplex receptacles protected by (2) 3-Pole circuit breaker, (3) 20A 1-Pole circuit breakers

**SPECIFICATIONS**

RATING	80A, 120/208VAC, 3P+N+G
ENVIRONMENTAL RATING	Indoor use
INPUT	(5) E16 Camlocks, 3P+N+G
OUTPUT	(2) 30A L21-30R Rec. (3) 20A 5-20 Duplex Rec.
OVERCURRENT PROTECTION	(2) 30A 3-Pole, MCB (3) 20A 1-Pole, MCB
DIMENSIONS	L 11” W 12” H 14”
WEIGHT	19 lbs.



1

2

3

4

5

6

7

8

9

10

**HEB & HEBE Series of Portable Power Distribution**

**HEB3104U**

PROTECTION:  
(2) 30A 3P MCB  
(3) 20A 1P MCB

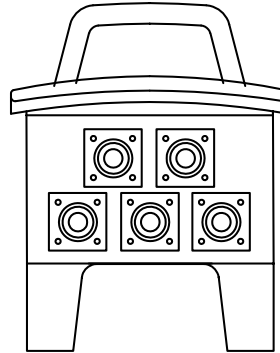
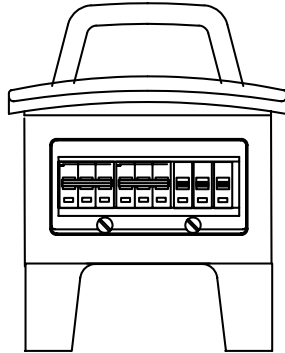

INPUT:  
(5) E16 CAMLOCKS  
120/208V, 3P+N+G

OUTPUT:  
(3) 20A GFCI

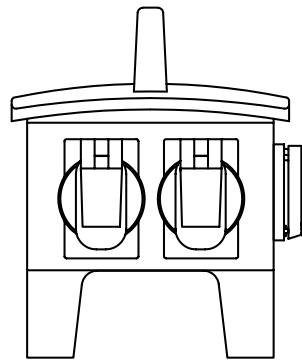
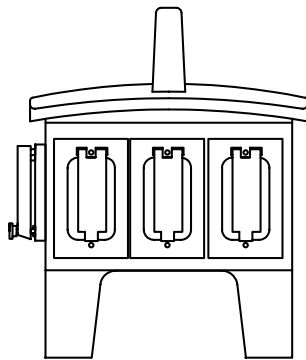

OUTPUT:  
(2) 30A L21-30R  
W/W COVER

INLET  
(5) CAMLOCKS

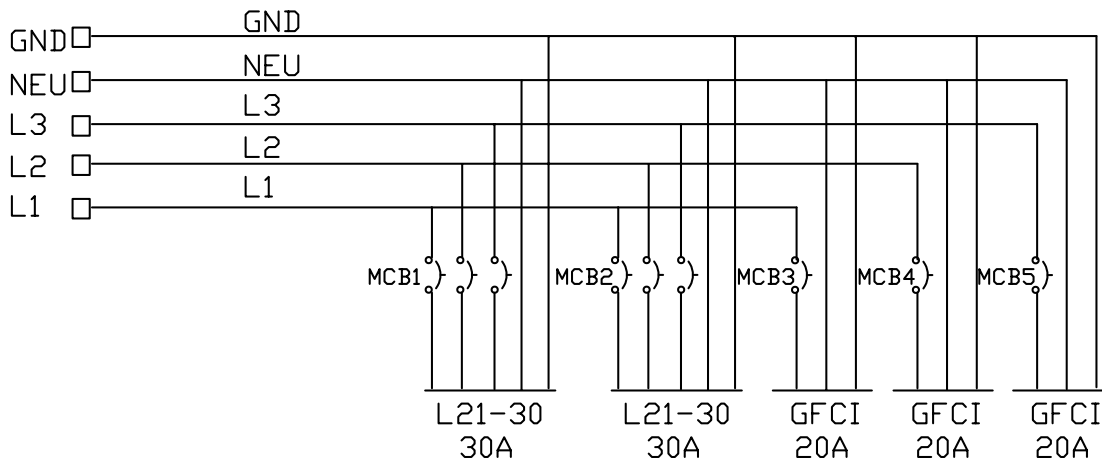



**HEB3104U**

**80A, 3-PH, 3-Pole, 5-Wire, UL Listed**

**DESCRIPTION**

120/208VAC, Three Phase one tier PDU with Input: (5) E16 Camlocks, 3-Pole, 5 Wire, Output: (2) 30A Twist lock, NEMA L21-30R, 3-Pole, 5 Wire with weather cover, receptacles, (3) 20A Duplex GFCI receptacles with weather cover protected by (2) 3-Pole circuit breakers, (3) 20A 1-Pole circuit breakers

**SPECIFICATIONS**

RATING	80A, 120/208VAC, 3P+N+G
ENVIRONMENTAL RATING	NEMA 3R
INPUT	(5) E16 Camlocks, 3P+N+G
OUTPUT	(2) 30A L21-30R Rec. (3) 20A Duplex GFCI
OVERCURRENT PROTECTION	(2) 30A 3-Pole, MCB (3) 20A 1-Pole, MCB
DIMENSIONS	L 11” W 12” H 14”
WEIGHT	19 lbs.



- 1
- 2
- 3
- 4
- 5
- 6
- 7
- 8
- 9
- 10

HEB & HEBE Series of Portable Power Distribution

**HEB3105U**

PROTECTION:  
(8) 20A 1P MCB

(6) 20A 1P MCB

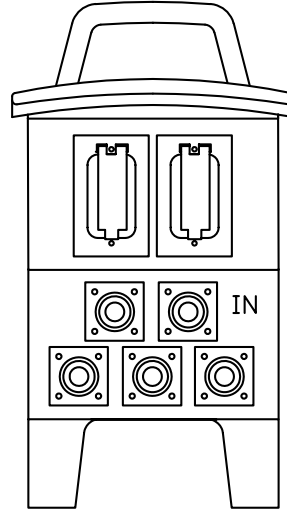
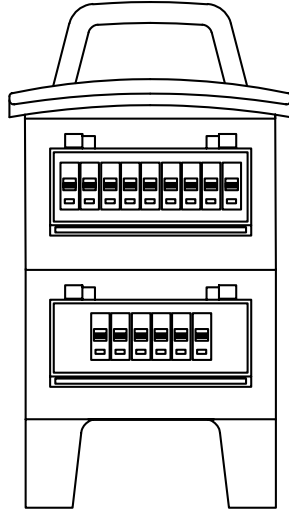

OUTPUT:

(2) 20A GFCI  
W/W.COVERS

INPUT:

(5) E16 CAMLOKS  
120/208V, 3P+N+G

OUTPUT:

(3) 20A GFCI  
W/W.COVERS

(3) 20A GFCI  
W/W.COVERS

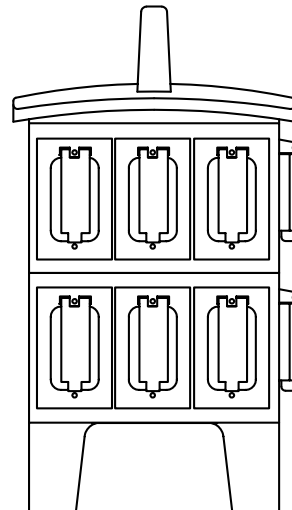
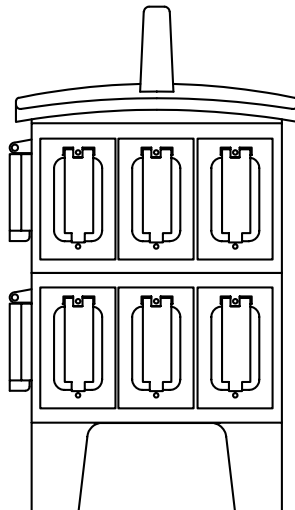

OUTPUT:

(3) 20A GFCI  
W/W.COVERS

(3) 20A GFCI  
W/W.COVERS

**HEB3105U**

**100A, 3-PH, 3-Pole, 5-Wire, UL Listed**

**DESCRIPTION**

120/208VAC, Three Phase double tier PDU with Input: of (5) E16 Camlocks, 3-Pole, 5 Wire, Output: (14) 20A, NEMA 5-20 Duplex GFCI 1-Pole, 3 Wire receptacles with weather cover protected by (14) 20A 1-Pole circuit breaker

**SPECIFICATIONS**

RATING	100A, 120/208VAC, 3P+N+G
ENVIRONMENTAL RATING	NEMA 3R
INPUT	(5) E16 Camlocks, 3P+N+G
OUTPUT	(14) 20A Duplex GFCI Receptacle
OVERCURRENT PROTECTION	(14) 20A 1-Pole, MCB
DIMENSIONS	L 11.5” W 12.5” H 19”
WEIGHT	35 lbs.



- 1
- 2
- 3
- 4
- 5
- 6
- 7
- 8
- 9
- 10

HEB & HEBE Series of Portable Power Distribution

HEB3106BU

PROTECTION:  
(6) 20A, 1 POLE, MCB

(6) 20A, 1 POLE, MCB

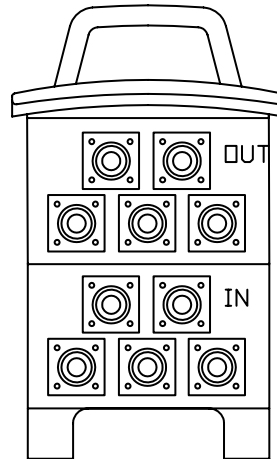
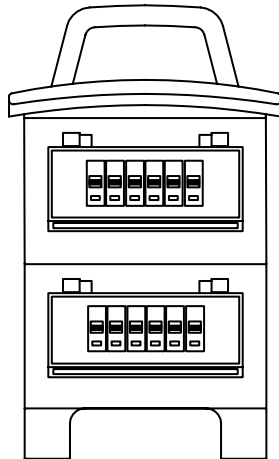

OUTPUT:  
UN-PROTECTED OUTPUT  
(5) 400A CAMLOKS  
120/208V

INPUT:  
(5) 400A CAMLOKS  
120/208V

OUTPUT:  
(3) 20A, DUPLEX  
W/W. COVERS

(3) 20A, DUPLEX  
W/W. COVERS

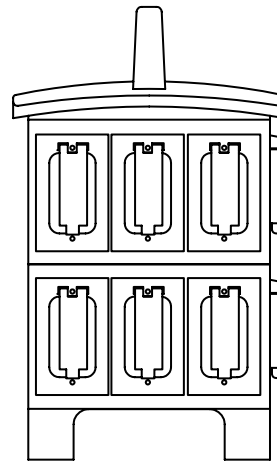
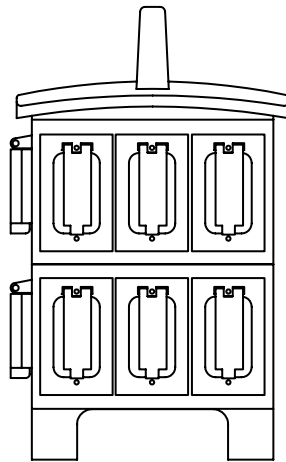

OUTPUT:  
(3) 20A, DUPLEX  
W/W. COVERS

(3) 20A, DUPLEX  
W/W. COVERS



**HEB3106BU**

**80A, 3-PH, 3-Pole, 5-Wire, UL Listed**

**DESCRIPTION**

120/208VAC, Three Phase double tier PDU with Input: of (5) E16 Camlocks, 3-Pole, 5 Wire, pass thru: (5) E16 Camlocks, 3-Pole, 5Wire with weather cover, Output: (12) 20A, NEMA 5-20 Duplex, 1-Pole, 3 Wire receptacles with weather cover protected by (12) 20A, 1-Pole circuit breaker

**SPECIFICATIONS**

RATING	80A, 120/208VAC, 3P+N+G
ENVIRONMENTAL RATING	NEMA 3R
INPUT	(5) E16 Camlocks, 3P+N+G
PASS THRU	(5) E16 Camlocks, 3P+N+G
OUTPUT	(12) 20A 5-20 Duplex Receptacle
OVERCURRENT PROTECTION	(12) 20A 1-Pole, MCB
DIMENSIONS	L 11.5" W 12.5" H 19"
WEIGHT	35 lbs.



- 1
- 2
- 3
- 4
- 5
- 6
- 7
- 8
- 9
- 10

HEB & HEBE Series of Portable Power Distribution

**HEB3106U**

PROTECTION:

(6) 20A, 1 POLE, MCBS

(6) 20A, 1 POLE, MCBS

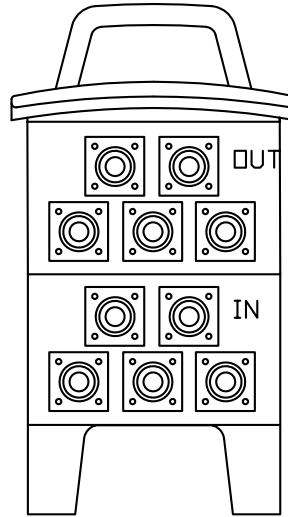
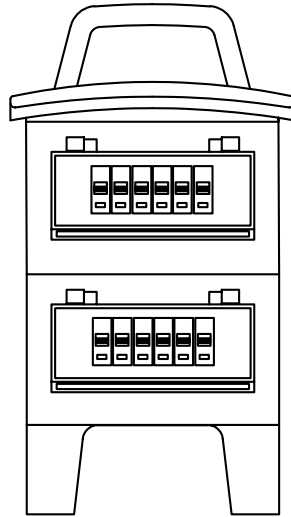

FEEDTHRU:  
(5) E16 CAMLOKS  
120/208V 3P+N+G  
REVERSE G,N

INPUT:  
(5) E16 CAMLOKS  
120/208V 3P+N+G  
REVERSE G,N

OUTPUT:

(3) 20A GFCI  
W/W.COVERS

(3) 20A GFCI  
W/W.COVERS

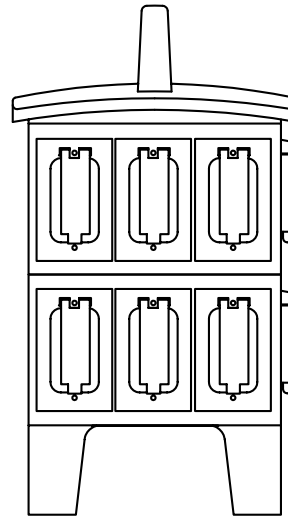
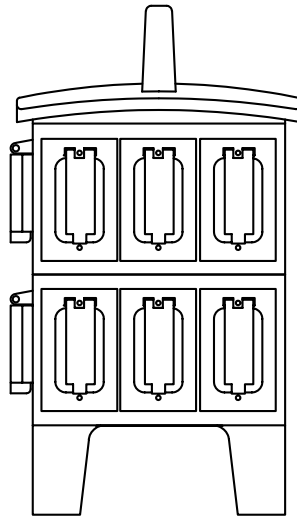

OUTPUT:

(3) 20A GFCI  
W/W.COVERS

(3) 20A GFCI  
W/W.COVERS

**HEB3106U**

**80A, 3-PH, 3-Pole, 5-Wire, UL Listed**

**DESCRIPTION**

120/208VAC, Three Phase double tier PDU with Input: of (5) E16 Camlocks, 3-Pole, 5 Wire, pass thru: (5) E16 Camlocks, 3-Pole, 5Wire with weather cover, Output: (12) 20A, NEMA 5-20 Duplex GFCI , 1-Pole, 3 Wire receptacles with weather cover protected by (12) 20A, 1-Pole circuit breakers

**SPECIFICATIONS**

RATING	80A, 120/208VAC, 3P+N+G
ENVIRONMENTAL RATING	NEMA 3R
INPUT	(5) E16 Camlocks, 3P+N+G
PASS THRU	(5) E16 Camlocks, 3P+N+G
OUTPUT	(12) 20A Duplex, GFCI Rec.
OVERCURRENT PROTECTION	(12) 20A 1-Pole, MCB
DIMENSIONS	L 11.5" W 12.5" H 19"
WEIGHT	35 lbs.



- 1
- 2
- 3
- 4
- 5
- 6
- 7
- 8
- 9
- 10

HEB & HEBE Series of Portable Power Distribution

**HEB3107AU**

PROTECTION:  
(8) 20A 1P MCB

(6) 20A 1P MCB

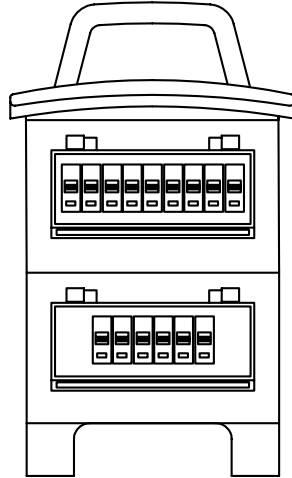

OUTPUT:  
(2) 20A 5-20

INPUT:  
(5) E16 CAMLOCKS  
120/208V, 3P+N+G

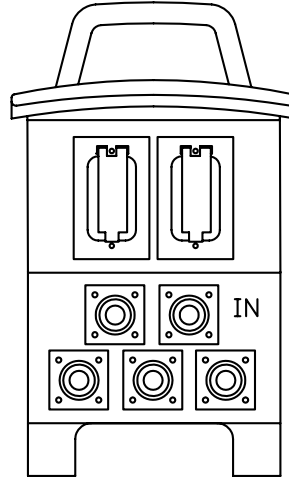

OUTPUT:  
(3) 20A 5-20

OUTPUT:  
(3) 20A 5-20

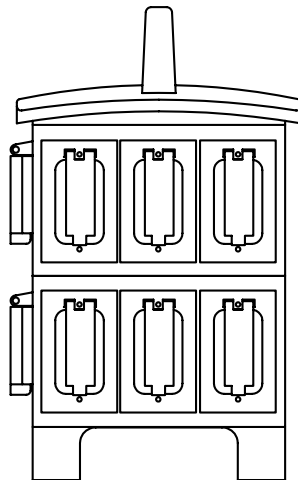

OUTPUT:  
(3) 20A 5-20

OUTPUT:  
(3) 20A 5-20

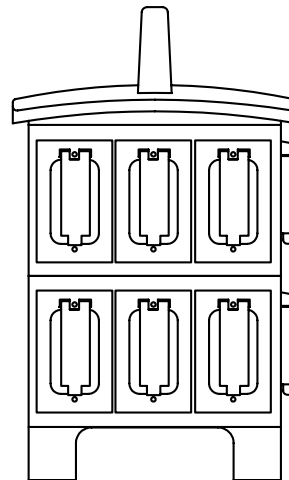



**HEB3107AU**

**100A, 3-PH, 3-Pole, 5-Wire, UL Listed**

**DESCRIPTION**

120/208VAC, Three Phase double tier PDU with Input: of (5) E16 Camlocks, 3-Pole, 5 Wire, Output: (14) 20A, NEMA 5-20 Duplex, 1-Pole, 3 Wire receptacles with weather cover protected by (14) 20A 1-Pole circuit breaker

**SPECIFICATIONS**

RATING	100A, 120/208VAC, 3P+N+G
ENVIRONMENTAL RATING	NEMA 3R
INPUT	(5) E16 Camlocks, 3P+N+G
OUTPUT	(14) 20A, 5-20 Duplex Receptacle
OVERCURRENT PROTECTION	(14) 20A 1-Pole, MCB
DIMENSIONS	L 11.5" W 12.5" H 19"
WEIGHT	35 lbs.



- 1
- 2
- 3
- 4
- 5
- 6
- 7
- 8
- 9
- 10

HEB & HEBE Series of Portable Power Distribution

**HEB32601**

PROTECTION:  
<2> 30A 3P MCB

<2> 30A 3P MCB

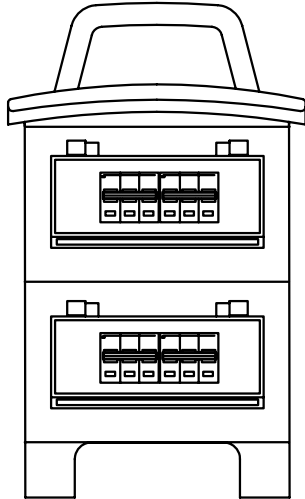

FRONT

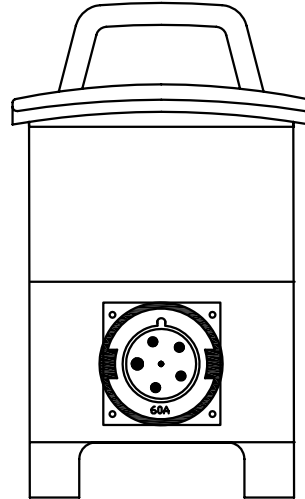

BACK

INPUT:  
60A IEC 3PH 5W  
120/208V, 3P+N+G

OUTPUT:  
<1> L21-30R

<1> L21-30R

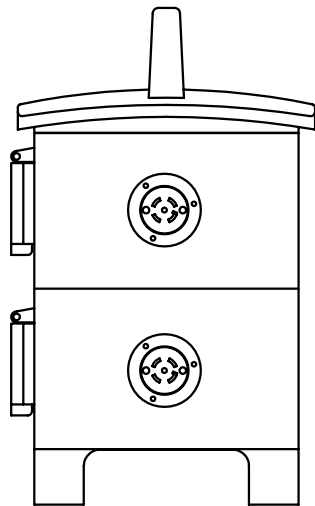

RIGHT

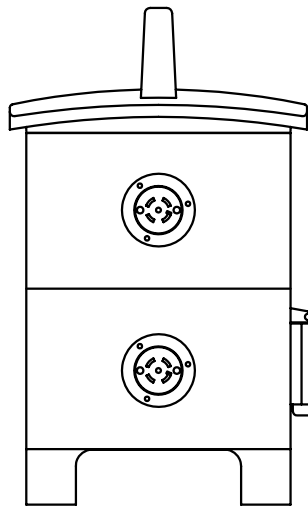

LEFT

OUTPUT:  
<1> L21-30R

<1> L21-30R

**HEB32601**

**60A, 3-PH, 3-Pole, 5-Wire, UL Listed**

**DESCRIPTION**

120/208VAC, Three Phase double tier PDU with Input: of (1) 60A IEC60309 IP67, 3-Pole, 5 Wire inlet, Output: (4) 30A Twist lock, NEMA L21-30R, 3-Pole, 5 Wire receptacles, protected by (4) 30A 3-Pole circuit breaker

**SPECIFICATIONS**

RATING	60A, 120/208VAC, 3P+N+G
ENVIRONMENTAL RATING	Indoor use
INPUT	(1)60A IEC IP67, 3P+N+G
OUTPUT	(4) 30A L21-30R, 3P+N+G Receptacle
OVERCURRENT PROTECTION	(4) 30A 3-Pole, MCB
DIMENSIONS	L 11.5” W 12.5” H 19”
WEIGHT	32 lbs.



1

2

3

4

5

6

7

8

9

10

**HEB & HEBE Series of Portable Power Distribution**

**HEB201X3U**

PROTECTION:  
(1) 50A 2P MCB  
(6) 20A 1P MCB

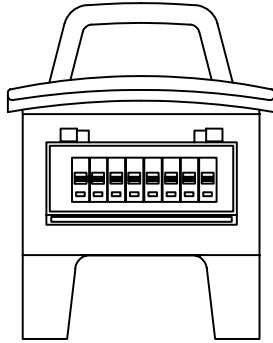

FRONT

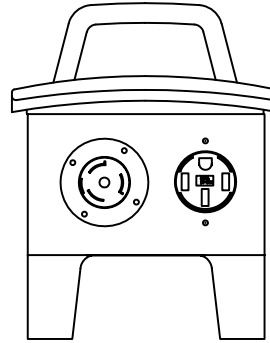

BACK

INPUT:  
50A INLET CS6375  
120/250V 2P+N+G

PASSTHRU:  
50A 14-50R  
120/250V 2P+N+G

OUTPUT:  
(3) 20A 5-20 DPX

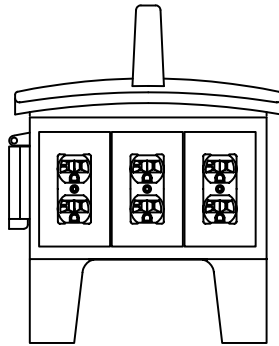

RIGHT

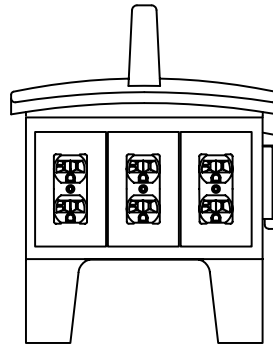

LEFT

OUTPUT:  
(3) 20A 5-20 DPX

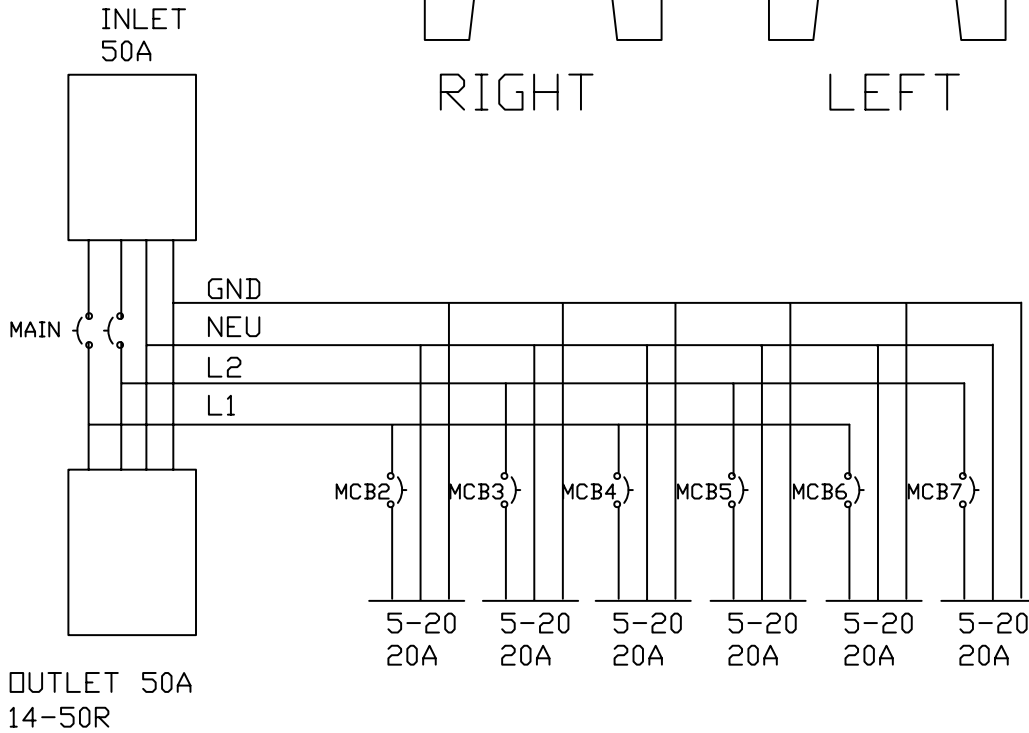

**HEB201X3U**

**50A, 1-PH, 2-Pole, 4-Wire, UL Listed**

**DESCRIPTION**

120/208VAC, Single Phase one tier PDU with Input: (1) 50A Twist lock, CS6375, 2-Pole, 4 Wire inlet, Passthru: (1) 50A 14-50R, 2-Pole, 4 Wire Receptacle, Output: (6) 20A NEMA 5-20R Duplex receptacles protected by (1) 50A 2-Pole circuit breaker (main), (6) 20A 1-Pole circuit breakers

**SPECIFICATIONS**

RATING	50A, 120/208VAC, 2P+N+G
ENVIRONMENTAL RATING	Indoor use
INPUT	(1) 50A CS Type 2P+N+G Inlet
PASSTHRU	(1) 50A 14-50R Receptacle
OUTPUT	(6) 20A 5-20R Duplex
OVERCURRENT PROTECTION	(1) 50A 2-Pole, MCB (Main) (6) 20A 1-Pole, MCB
DIMENSIONS	L 11.5" W 12.5" H 14"
WEIGHT	19 lbs.



- 1
- 2
- 3
- 4
- 5
- 6
- 7
- 8
- 9
- 10



**HEB & HEBE Series of Portable Power Distribution**

**HEB362U**

PROTECTION:  
(6) 20A, 1POLE MCB

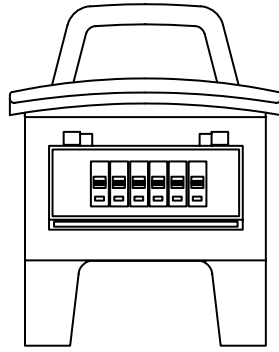

FRONT

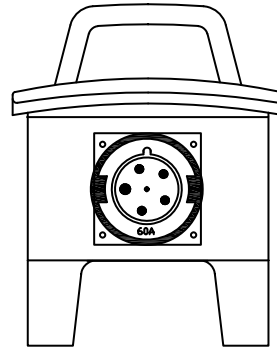

BACK

INPUT:  
60A IEC 3P+N+G  
120/250V

OUTPUT:  
(3) 20A GFCI  
W/W COVER

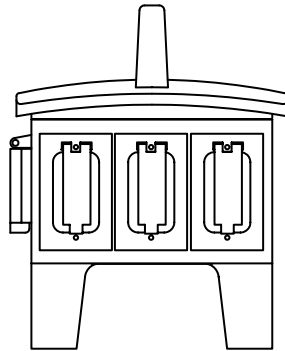

RIGHT

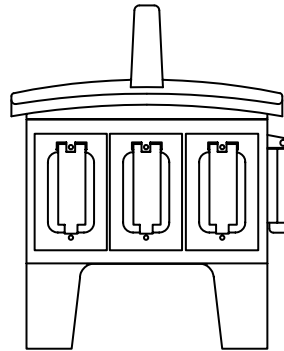

LEFT

OUTPUT:  
(3) 20A GFCI  
W/W COVER

INLET  
60A IEC 5W

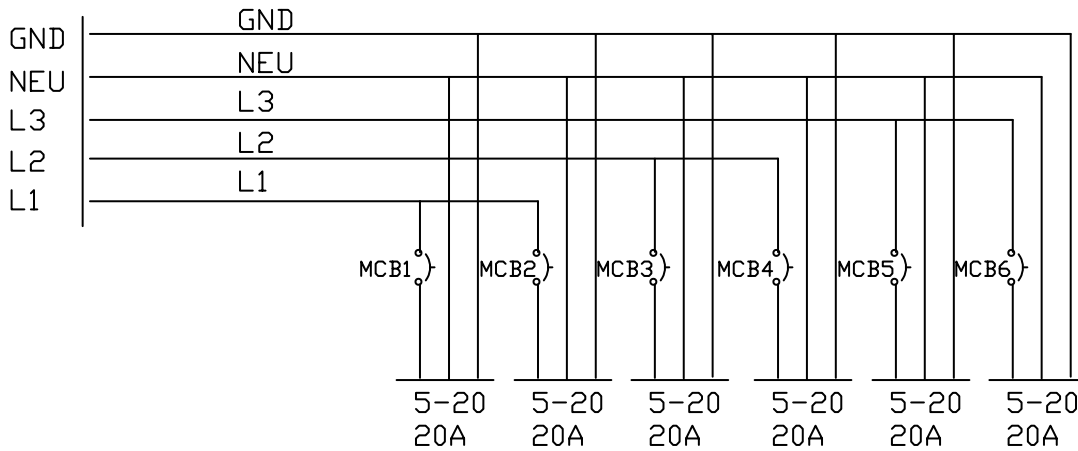

**HEB362U**

**40A, 3-PH, 3-Pole, 5-Wire, UL Listed**

**DESCRIPTION**

120/208VAC, Three Phase one tier PDU with Input: (1) 60A IEC60309 IP67, 3-Pole, 5 Wire inlet, Output: (6) 20A Duplex GFCI receptacles with weather cover protected by (6) 20A 1-Pole circuit breakers

**SPECIFICATIONS**

RATING	40A, 120/208VAC, 3P+N+G
ENVIRONMENTAL RATING	NEMA 3R
INPUT	(1) 60A IEC IP67, 3P+N+G Inlet
OUTPUT	(6) 20A Duplex GFCI Rec.
OVERCURRENT PROTECTION	(6) 20A 1-Pole, MCB
DIMENSIONS	L 11.5" W 12.5" H 14"
WEIGHT	19 lbs.



- 1
- 2
- 3
- 4
- 5
- 6
- 7
- 8
- 9
- 10

**HEB & HEBE Series of Portable Power Distribution**

**649110SP13**

**CUSTOM PDU, 100A, 1-PH, 1-Pole, 3-Wire, UL Listed**

**Description**

120 VAC, Single Phase one tier PDU with Input: (1) 100A Stage pin, 1-Pole, 3 Wire inlet, Pass thru: (1) 100A Stage pin, 1-Pole, 3 Wire receptacle, Output: (5) 20A NEMA 5-20R Duplex receptacles protected by (5) 20A 1-Pole circuit breakers.

**SPECIFICATION**

RATING	100A, 120VAC, 1P+N+G
ENVIRONMENTAL RATING	indoor use
INPUT	(1) 100A Stage pin, 1P+N+G Inlet
PASS THRU	(1) 100A Stage Pin, 1P+N+G Receptacle
OUTPUT	(5) 20A 5-20R Duplex
OVERCURRENT PROTECTION	(5) 20A 1-Pole, MCB
DIMENSIONS	L 11" W 12" H 14"
WEIGHT	18 lbs.



**HEBE113S1**

**CUSTOM PDU, 100A, 1-PH, 1-Pole, 3-Wire, UL Listed**

**DESCRIPTION**

100A/120V, Single Phase one tier PDU with Input: (1) 100A Stage pin, 1-Pole, 3 Wire inlet, with indicator light Pass thru: (1) 100A Stage pin, 1-Pole, 3 Wire receptacle, Output: (6) 20A NEMA 5-20R Duplex with weather cover receptacles protected by (6) 20A 1-Pole circuit breakers

**SPECIFICATIONS**

RATING	100A/120V, 1P+N+G
ENVIRONMENTAL RATING	Indoor use
INPUT	(1) 100A Stage pin, 1P+N+G Inlet
PASS THRU	(1) 100A Stage Pin, 1P+N+G Receptacle
OUTPUT	(6) 20A 5-20R Duplex
OVERCURRENT PROTECTION	(6) 20A 1-Pole, MCB
DIMENSIONS	L 11" W 12" H 14"
WEIGHT	18 lbs.



**HEBE235C5**

**CUSTOM PDU 160A, 3-PH, 3-Pole, 5 Wire**

**Description**

120/208VAC, Three Phase double tier PDU with Input: (5) E16 camlocks, 3-Pole, 5 Wire, Output: (4) Socapex 419 female panel mount protected by (24) 20A 1-Pole circuit breakers

**SPECIFICATIONS**

RATING	160A, 120/208VAC, 3P+N+G
ENVIRONMENTAL RATING	Indoor use
INPUT	(5) E16 Camlocks, 3P+N+G
OUTPUT	(4) Socapex 419
OVERCURRENT PROTECTION	(24) 20A 1-Pole, MCB
DIMENSIONS	L 11" W 12" H 19"
WEIGHT	31 lbs.



1

2

3

**HEBE235C3**

**CUSTOM PDU 240A, 3-PH, 3-Pole, 5 Wire**

**DESCRIPTION**

120/208VAC, Three Phase, Double tier with Input: (5) E16 camlocks, 3-Pole, 5 Wire, Output: (6) 100A Stage pin 1-Pole, 3 Wire female Panel mount, (4) 20A NEMA 5-20 Duplex Receptacles, protected by (6) 100A 1-Pole circuit breakers, (4) 20A 1-Pole circuit breakers

**SPECIFICATIONS**

RATING	240A, 120/208VAC, 3P+N+G
ENVIRONMENTAL RATING	Indoor use
INPUT	(5) E16 Camlocks, 3P+N+G
OUTPUT	(6) 100A, Stage pin, 1P+N+G (4) 20A 5-20R Duplex
OVERCURRENT PROTECTION	(6) 100A 1-Pole, MCB (4) 20A 1-Pole, MCB
DIMENSIONS	L 11" W 12" H 19"
WEIGHT	37 lbs.



4

5

6

**HEBE235C2**

**CUSTOM PDU 80A, 3-PH, 3-Pole, 5 Wire**

**DESCRIPTION**

120/208VAC, Three Phase double tier PDU with Input: (5) E16 camlocks, 3-Pole, 5 Wire, Pass thru: (5) E16 camlocks, 3-Pole, 5 Wire with weather cover, Output: (12) 20A NEMA 5-20 Single Receptacles in parallel with socapex, (2) Socapex 419 female panel mount protected by (12) 20A 1-Pole circuit breakers

**Specifications**

Rating	80A, 120/208VAC, 3P+N+G
Environmental Rating	Indoor use
Input	(5) E16 Camlocks, 3P+N+G
Pass thru	(5) E16 Camlocks, 3P+N+G
Output	(12) 20A 5-20 Single receptacles (2) Socapex 419
Overcurrent Protection	(12) 20A 1-Pole, MCB
Approximate Dimensions	L 11" W 12" H 19"
Approximate Weight	33 lbs.



7

8

9

10

**HEB & HEBE Series of Portable Power Distribution**

**HEBE235C1**

**CUSTOM PDU 80A, 3-PH, 3-Pole, 5 Wire**

**DESCRIPTION**

80A, 120/208VAC, Three Phase, Double tier PDU, DMX & Splitter Power with Input: (5) E16 camlocks, 3-Pole, 5 Wire, (1) DMX Inlet, Output: (4) DMX Outlet, (6) Powercon true Outlet, (6) 20A NEMA 5-20 single Receptacles in parallel with socapex, (1) Socapex 419 female panel mount protected by (12) 20A 1-Pole circuit breakers, (1) 0.5A 1-Pole circuit breaker

**SPECIFICATIONS**

RATING	80A, 120/208VAC, 3P+N+G
ENVIRONMENTAL RATING	Indoor use
INPUT	(5) E16 Camlocks, (1) DMX Inlet
OUTPUT	(6) 20A 5-20 Single receptacles (6) Powercon True (4) DMX Outlet (1) Socapex 419
OVERCURRENT PROTECTION	(12) 20A 1-Pole, MCB (1) 0.5A 1-Pole, MCB
DIMENSIONS	L 11" W 12" H 19"
WEIGHT	32 lbs.



**HEBE135N1**

**CUSTOM PDU 20A, 3-PH, 3-Pole, 5 Wire**

**DESCRIPTION**

20A 120/208VAC, Three Phase single tier PDU with Input: (1) 20A Twist lock NEMA L21-20R, 3-Pole, 5 Wire inlet, (1) DMX Inlet, Pass thru: (1) DMX Outlet, Output: (4) DMX Outlet, (6) Powercon Outlet protected by (1) 20A 3-Pole circuit breakers, (1) 0.5A 1-Pole circuit breaker

**SPECIFICATIONS**

RATING	20A, 120/208VAC, 3P+N+G
ENVIRONMENTAL RATING	Indoor use
INPUT	(1) 20A L21-20R, (1) DMX Inlet
PASS THRU	(1) DMX Outlet
OUTPUT	(6) Powercon True (4) DMX Outlet
OVERCURRENT PROTECTION	(1) 20A 3-Pole, MCB (1) 0.5A 1-Pole, MCB
DIMENSIONS	L 11" W 12" H 14"
WEIGHT	16 lbs.



**HEBE113S2**

**CUSTOM PDU, 100A, 1-PH, 1-Pole, 3-Wire, UL Listed**

**DESCRIPTION**

20A 120/208VAC, Three Phase single tier PDU with Input: (1) 20A Twist lock NEMA L21-100A/120V, Single Phase one tier PDU with Input: (1) 100A Stage pin, 1-Pole, 3 Wire, with indicator light Pass thru: (1) 100A Stage pin, 1-Pole, 3 Wire receptacle, Output: (6) 20A NEMA 5-20R Duplex receptacles protected by (6) 20A 1-Pole circuit breakers

**SPECIFICATIONS**

RATING	100A/120V, 1P+N+G
ENVIRONMENTAL RATING	Indoor use
INPUT	(1) 100A Stage pin, 1P+N+G Inlet
PASS THRU	(1) 100A Stage Pin, 1P+N+G Receptacle
OUTPUT	(6) 20A 5-20R Duplex
OVERCURRENT PROTECTION	(6) 20A 1-Pole, MCB
DIMENSIONS	L 11" W 12" H 14"
WEIGHT	18 lbs.







- 1
- 2
- 3
- 4
- 5
- 6
- 7
- 8
- 9
- 10

**PDU Quote Request Form**

**QUOTE REQUESTED BY** \_\_\_\_\_

**DATE:** \_\_\_\_\_

**NAME** \_\_\_\_\_  
**COMPANY** \_\_\_\_\_  
**ADDRESS** \_\_\_\_\_  
 \_\_\_\_\_  
**PHONE** \_\_\_\_\_  
**EMAIL** \_\_\_\_\_

**ENCLOSURE TYPE**     **PORTABLE**         **WALL MOUNT**

**INPUT**

**TYPE                      AMPS      VOLTS      POLES      WIRES**

<b>HARDWIRE</b>							
<b>PIN SLEEVE</b>							
<b>TWISTLOCK</b>							
<b>CAMLOK</b>							

**OUTPUT**

**TYPE                      QUANTITY      AMPS      VOLTS      POLES      WIRES**

<b>PIN SLEEVE</b>							
<b>TWISTLOCK</b>							
<b>CAMLOK</b>							
<b>STRAIGHT BLADE</b>							
<b>OTHER</b>							

**Number of Units** \_\_\_\_\_ **Requested Delivery Date** \_\_\_\_\_

**NOTE: USE NEXT PAGE FOR ADDITIONAL INFORMATION**

## OTHER REQUIREMENTS

---

---

---

---

---

---

---

---

---

---

## SKETCH

- 1
- 2
- 3
- 4
- 5
- 6
- 7
- 8
- 9
- 10

**Beverage & Food Processing, Wineries**

**685X230HE**

**CUSTOM PDU, 300A, 3-PH, 3-Pole, 5-Wire**

**DESCRIPTION**

Two back to back 685 enclosure PDU with (3) Inputs hard wire by customer, Input-1: 480V, 3-Phase + Ground, Output: (2) 100A, IEC60309, IP67 receptacles, (2) 60A, IEC60309, IP67 receptacles protected by (2) 100A, 3-Pole circuit breakers, (2) 50A 3-Pole circuit breakers, Input-2: 220V, 3-Phase + Ground, Output: (2) 60A, IEC60309, IP67 receptacles, protected by (2) 50A 3-Pole circuit breakers, Input-3: 120/208V, 3-Phase + Neutral + Ground, Output: (2) 20A Twist lock, L21-30R receptacles, (2) 20A Twist lock, L5-20R receptacles protected by (2) 20A 3-Pole circuit breakers, (2) 30A 1-Pole circuit breakers.

**SPECIFICATIONS**

ENVIRONMENTAL RATING	NEMA 3R
INPUT 1	480V, Hard wire by the customer
OUTPUT 1	(2) 60A, 480V, IEC, IP67, 3P+G (2) 100A, 480V, IEC, IP67, 3P+G
INPUT 2	220V, Hard wire by the customer
OUTPUT 2	(2) 60A, 220V, IEC, IP67 3P+G
INPUT 3	120/208V, Hard wire by the customer
OUTPUT 3	(2) 20A, L5-20R Rec., (2) 30A, L21-30R Rec.
OVERCURRENT PROTECTION	(2) 100A 3-Pole, MCB; (4) 50A 3-Pole, MCB (2) 20A 1-Pole, MCB; (2) 30A 3-Pole, MCB
DIMENSIONS	L 16" W 18" H 46"
WEIGHT	125 lbs.



**649106I3501**

**CUSTOM PDU, 60A, 3-PH, 3-Pole, 5-Wire, UL Listed**

**DESCRIPTION**

120/208VAC, Three Phase single tier PDU with Input: (1) 60A IEC60309 IP67, 3-Pole, 5 Wire inlet , Output: (1) 30A Twist lock, L6-30R, 2-Pole, 3 Wire receptacle, (1) 20A Twist lock, L6-20R, 2-Pole, 3 Wire receptacle, (3) 20A Duplex GFCI receptacles, protected by (1) 30A 2-Pole circuit breaker, (1) 20A 2-Pole circuit breaker, (3) 20A 1-Pole circuit breakers.

**SPECIFICATIONS**

RATING	60A, 120/208VAC, 3P+N+G
ENVIRONMENTAL RATING	NEMA 3R
INPUT	(1) 60A IEC IP67, 3P+N+G Inlet
OUTPUT	(1) 30A L6-30R, 2P+G Rec. (1) 20A L6-20R, 2P+G Rec. (3) 20A Duplex, GFCI Rec.
OVERCURRENT PROTECTION	(1) 30A 2-Pole, MCB (1) 20A 2-Pole, MCB (3) 20A 1-Pole, MCB
DIMENSIONS	L 11.5" W 12.5" H 14"
WEIGHT	21 lbs.



**649230C34**

**Custom PDU, 300A, 3-PH, 3-Pole, 5-Wire, UL Listed**

**DESCRIPTION**

250VAC, Three Phase double tier PDU with Input: (5) E16 Camlocks, 3-Pole, 5 Wire, Output: (6) 50A CS Type, 3-Pole, 4 Wire receptacles with weather cover protected by (6) 50A 3-Pole circuit breakers.

**SPECIFICATIONS**

RATING	300A, 250VAC, 3P+N+G
ENVIRONMENTAL RATING	NEMA 3R
INPUT	(5) E16 Camlocks, 3P+N+G
OUTPUT	(6) 50A CS TYPE, 3P+G Receptacles
OVERCURRENT PROTECTION	(6) 50A 3-Pole, MCB
DIMENSIONS	L 11.5" W 12.5" H 19"
WEIGHT	35 lbs.



1

2

3

4

**649230CC**

**CUSTOM PDU, 170A, 3-PH, 3-Pole, 5 Wire, UL Listed**

**DESCRIPTION**

120/208VAC, Three Phase, double tier PDU with Input: (5) E16 Camlocks, 3-Pole, 5 Wire with indicator light for each phase, Pass thru: (5) E16 Camlocks, 3-Pole, 5 Wire with weather cover, Output: (6) 30A Twist lock, NEMA L21-30R, 3-Pole, 5 Wire receptacles, (1) 20A 5-20 Duplex receptacle protected by (6) 30A 3-Pole circuit breakers, (1) 20A 1-Pole circuit breaker.

**SPECIFICATIONS**

RATING	170A, 120/208VAC 3P+N+G
ENVIRONMENTAL RATING	NEMA 3R
INPUT	(5) E16 Camlocks, 3P+N+G
PASS THRU	(5) E16 Camlocks, 3P+N+G
OUTPUT	(6) 30A L21-30R, 3P+N+G. (1) 20A 5-20 Duplex
OVERCURRENT PROTECTION	(6) 30A 3-Pole, MCB (3) 20A 1-Pole, MCB
DIMENSIONS	L 11" W 12" H 25"
WEIGHT	32 lbs.



5

6

7

8

9

10



**68903ITWU**

**CUSTOM PDU 30A, 3-PH, 3-Pole, 4-Wire, UL Listed**

**DESCRIPTION**

7.5 KVA Single Phase step down transformer, 480V Primary-120 Secondary volt, with three phase, Input: (1) 30A IEC60309 IP67, 3-Pole, 4 Wire inlet, Output: (1) 30A, 480V IEC60309 IP67, 3-Pole, 4 Wire receptacle, (3) 20A 5-20 Duplex receptacles, (3) 20A 5-20 Single receptacles protected by (1) 30A 3-Pole circuit breaker, (1) 30A 2-Pole circuit breaker (1) 60A 1-Pole circuit breaker, (6) 20A 1-Pole circuit breakers.

**SPECIFICATIONS**

RATING	30A, 480/120VAC, 3P+G
ENVIRONMENTAL RATING	NEMA 3R
INPUT	(1) 30A IEC IP67, 3P+G Inlet
OUTPUT	(1) 30A, 480V IEC IP67, 3P+G (3) 20A 5-20 Duplex Separated (3) 20A 5-20 Single
OVERCURRENT PROTECTION	(1) 30A 3-Pole MCB (1) 30A 2-Pole MCB (1) 60A 1-Pole MCB (6) 20A 1-Pole MCB
DIMENSIONS	L 22" W 19" H 51"
WEIGHT	140 lbs.



**682103ITWU**

**CUSTOM PDU 30A, 3-PH, 3-Pole, 4-Wire, UL Listed**

**Description**

7.5 KVA Single Phase step down transformer, 480V Primary -120 Secondary volt, with three phase Input: (1) 30A IEC60309 IP67, 3-Pole, 4 Wire inlet, Output: (1) 30A, 480V IEC60309, IP67, 3-Pole, 4 Wire receptacle, (3) 20A 5-20 Duplex separated receptacles protected by (1) 30A 3-Pole circuit breaker, (1) 60A 1-Pole circuit breaker, (6) 20A 1- Pole circuit breakers.

**SPECIFICATIONS**

RATING	30A, 480/120VAC, 3P+G
ENVIRONMENTAL RATING	NEMA 3R
INPUT	(1) 30A IEC IP67, 3P+G Inlet
OUTPUT	(1) 30A, 480v, IEC, IP67, 3P+G (3) 20A 5-20 Duplex Separated
OVERCURRENT PROTETION	(1) 30A 3-Pole MCB (1) 60A 1-Pole MCB (6) 20A 1-Pole MCB
DIMENSIONS	L 22" W 19" H 51"
WEIGHT	140 lbs.



NOTE: Color of hand truck may vary

# Dual Utility Pedestal 30A/480V, 20A/120V

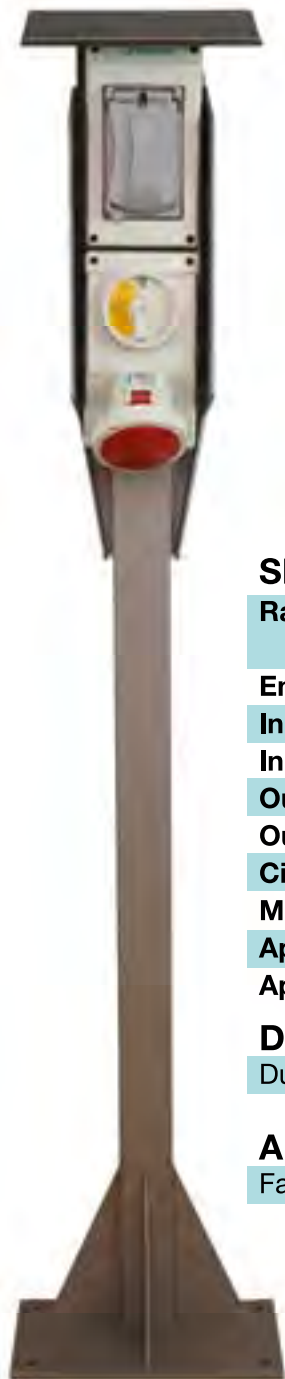

### Features and Benefits

- Non conductive, UV resistant, plastic enclosures
- Mechanical interlocking switch
- Stainless steel pedestal to protect mechanical interlock and GFCI duplex
- Walther can produce and supply the mating connectors and cable assemblies

### SPECIFICATIONS

<b>Rating</b>	30A/480V~3PH 20A/120V~1PH
<b>Environment Rating</b>	NEMA 3R
<b>Input-1</b>	20A/120V, 1P+N+G (Hard wire)
<b>Input-2</b>	30A/480V, 3P+G (Hard wire)
<b>Output-1</b>	(1) 20A/120V GFCI Duplex
<b>Output-2</b>	(1) 30A/480V IEC60309, IP67, 3P+G Receptacle
<b>Circuit-2 Protection</b>	32A, 3-Pole, IP67 Mechanical interlock switch
<b>Mechanical Interlock Switch</b>	32A/480V, 3-Pole, IP67
<b>Approximate Dimensions</b>	L 8" W 9" H 58"
<b>Approximate Weight</b>	29 lbs.

### DESCRIPTION

Dual utility receptacles mounted on stainless steel pedestal

### APPLICATION

Factories, Food processing, Wineries, Marine/Ship building, etc.

1

2

3

4

5

6

7

8

9

10

**649112MC24**

**Custom PDU, 120A, 1-PH, 2-Pole, 4-Wire UL Listed**

**DESCRIPTION**

120/250VAC, Single Phase single tier with Input: (4) E15 Camlocks, 2-Pole, 4 Wire (neutral and ground reverse), Output: (2) 50A NEMA 14-50R, 2-Pole, 4 Wire receptacles, (1) 20A GFCI Duplex Protected by (2) 50A 2-Pole circuit breakers, (2) 20A 1-Pole circuit breakers.

**SPECIFICATIONS**

RATING	120A, 120/250VAC, 2P+N+G
ENVIRONMENTAL RATING	NEMA 3R
INPUT	(4) E15 Camlocks, 2P+N+G
OUTPUT	(2) 50A 14-50R, 2P+N+G (2) 20A Duplex GFCI
OVERCURRENT PROTECTION	(2) 50A 2-Pole, MCB (2) 20A 1-Pole, MCB
DIMENSIONS	L 11" W 12" H 14"
WEIGHT	15 lbs.



**649212CC35**

**Custom PDU, 120A, 3PH, 3-Pole, 5 Wire, UL Listed**

**DESCRIPTION**

120/208VAC, Three Phase double tier with Input: (5) E16 Camlocks, 3-Pole, 5 Wire, Pass thru: (5) E16 Camlocks, 3-Pole, 5 Wire, with weather cover, Output: (1) 50A CS Type, 2-Pole, 3 Wire receptacle with weather cover, (2) 30A 6-30R, 2-Pole, 3 Wire receptacles with weather cover, (2) 20A 6-20R, 2-Pole, 3 Wire receptacles with weather cover (2) 20A Duplex 5-20 with weather cover protected by (1) 50A 2-Pole circuit breaker, (2) 30A 2-Pole circuit breakers, (2) 20A 2-Pole circuit breakers, (2) 20A 1-Pole circuit breakers.

**SPECIFICATIONS**

RATING	120A, 120/208VAC, 3P+N+G
ENVIRONMENTAL RATING	NEMA 3R
INPUT	(5) E16 Camlocks, 3P+N+G
PASS THRU	(5) E16 Camlocks, 3P+N+G
OUTPUT	(1) 50A 6-50R, (2) 30A 6-30R; (2) 20A 6-20R, (2) 20A Duplex
OVERCURRENT PROTECTION	(1) 50A 2-Pole, MCB; (2) 30A 2-Pole, MCB (2) 20A 2-Pole, MCB; (2) 20A 1-Pole, MCB
DIMENSIONS	L 11.5" W 12.5" H 19"
WEIGHT	34 lbs.



**6491051E**

**CUSTOM PDU, 50A, 1-PH, 2-Pole, 4-Wire, UL Listed**

**DESCRIPTION**

120/208VAC, Single Phase one tier PDU with Input: (1) 50A Twist lock CS6375LC, 2-Pole, 4 Wire inlet, Output: (6) 20A Duplex GFCI receptacles with weather cover protected by (6) 20A 1-Pole circuit breakers.

**SPECIFICATIONS**

RATING	50A, 120/208VAC, 2P+N+G
ENVIRONMENTAL RATING	NEMA 3R
INPUT	(1) 50A CS Type 2P+N+G
OUTPUT	(6) 20A Duplex GFCI
OVERCURRENT PROTECTION	(6) 20A 1-Pole, MCB
DIMENSIONS	L 11.5" W 12.5" H 14"
WEIGHT	19 lbs.



- 1
- 2
- 3

**649210C35**

**Custom PDU, 100A, 3-PH, 3-Pole, 5-Wire, UL Listed**

**DESCRIPTION**

120/208VAC, Three Phase double tier PDU with Input: of (5) E16 Camlocks, 3-Pole, 5 Wire, Output: (15) 20A, NEMA 5-20 Duplex, 1-Pole, 3 Wire receptacles with weather cover protected by (15) 20A 1-Pole circuit breaker.

**SPECIFICATIONS**

RATING	100A, 120/208VAC, 3P+N+G
ENVIRONMENTAL RATING	NEMA 3R
INPUT	(5) E16 Camlocks, 3P+N+G
OUTPUT	(15) 20A, 5-20 Duplex Receptacle
OVERCURRENT PROTECTION	(15) 20A 1-Pole, MCB
DIMENSIONS	L 11.5" W 12.5" H 19"
WEIGHT	35 lbs.



- 4
- 5
- 6
- 7
- 8
- 9
- 10

**649214MC35**

**Custom PDU, 140A, 3-PH, 3-Pole, 5-Wire, UL Listed**

**DESCRIPTION**

120/208VAC, Three Phase double tier with Input: (5) E15 Mini Camlocks, 3-Pole, 5 Wire, Output: (1) 50A CS Type, 2-Pole, 4 Wire receptacle with weather cover, (1) 30A Twist lock, NEMA L6-30R, 2-Pole, 4 Wire receptacle with weather cover, (2) 30A IEC309 IP67, 3-Pole 5 Wire receptacles, (2) 20A GFCI with weather cover protected by (1) 50A 3-Pole circuit breaker, (1) 30A 2-Pole circuit breaker, (2) 30A 3-Pole circuit breakers, (2) 20A 1-Pole circuit breaker.

**SPECIFICATIONS**

RATING	140A, 120/208VAC, 3P+N+G
ENVIRONMENTAL RATING	NEMA 3R
INPUT	(5) E15 Mini Camlocks, 3P+N+G
OUTPUT	(1) 50A CS TYPE, 3P+G; (1) 30A L6-30R, 2P+N+G (2) 30A IEC IP67, 3P+N+G; (2) 20A Duplex GFCI
OVERCURRENT PROTECTION	(1) 50A 2-Pole, MCB; (1) 30A 2-Pole, MCB (2) 30A 3-Pole, MCB; (2) 20A 1-Pole, MCB
DIMENSIONS	L 11.5" W 12.5" H 19"
WEIGHT	36 lbs.



**649215CM**

**CUSTOM PDU, 120A, 3-PH, 3-Pole, 4-Wire, UL Listed**

**DESCRIPTION**

480VAC, Three Phase double tier with Input: (4) E16 Camlocks, 3-Pole, 4 Wire, Output: (2) 60A IEC60309 IP67, 3-Pole, 4 Wire receptacles protected by (1) 150A 3-Pole main circuit breaker, (2) 60A 3-Pole circuit breakers.

**SPECIFICATIONS**

RATING	120A, 480VAC, 3P+G
ENVIRONMENTAL RATING	NEMA 3R
INPUT	(4) E16 Camlocks, 3P+G
OUTPUT	(2) 60A IEC IP67, 3P+G
OVERCURRENT PROTECTION	(1) 150A 3-Pole, MCCB (Main) (2) 60A 3-Pole, MCB
DIMENSIONS	L 11.5" W 12.5" H 19"
WEIGHT	32 lbs.



**649217CC35**

**CUSTOM PDU, 170A, 3-PH, 3-Pole, 5 Wire, UL Listed**

**DESCRIPTION**

120/208VAC, Three Phase double tier PDU with Input: (5) E16 Camlocks, 3-Pole, 5 Wire, Pass thru: (5) E16 Camlocks, 3-Pole, 5 Wire, Output: (5) 30A Twist lock, NEMA L21-30R, 3-Pole, 5 Wire receptacles, (3) 20A 5-20 Duplex receptacles protected by (5) 30A 3-Pole circuit breakers, (3) 20A 1-Pole circuit breakers.

**SPECIFICATIONS**

RATING	170A, 120/208VAC, 3P+N+G
ENVIRONMENTAL RATING	NEMA 3R
INPUT	(5) E16 Camlocks, 3P+N+G
PASS THRU	(5) E16 Camlocks, 3P+N+G
OUTPUT	(5) 30A L21-30R, 3P+N+G (3) 20A 5-20 Duplex
OVERCURRENT PROTECTION	(5) 30A 3-Pole, MCB (3) 20A 1-Pole, MCB
DIMENSIONS	L 11" W 12" H 25"
WEIGHT	39 lbs.





### 649220C3501

#### CUSTOM PDU, 200A, 3-PH, 3-Pole, 5 Wire, UL Listed

##### DESCRIPTION

120/208VAC, Three Phase double tier PDU with Input: (5) E16 Camlocks, 3-Pole, 5 Wire (ground and neutral reverse), Output: (1) 60A IEC60309, IP67, 3-Pole, 5 Wire receptacle, (1) 20A Twist lock, NEMA L21-20R, 3-Pole, 5 Wire receptacle, (2) 50A 5-20, CS Type, 2-Pole, 4 Wire receptacles, (1) 20A Twist lock, NEMA L5-20R, 1-Pole 3 Wire receptacle, (2) 20A GFCI protected by (1) 60A 3-Pole circuit breaker, (1) 20A 3-Pole circuit breaker, (2) 50A 2-Pole circuit breakers, (3) 20A 1-Pole circuit breakers.

##### SPECIFICATIONS

RATING	200A, 120/208VAC, 3P+N+G
ENVIRONMENTAL RATING	NEMA 3R
INPUT	(5) E16 Camlocks, 3P+N+G
OUTPUT	(1)60A IEC60309, IP67, 3P+N+G; (1)20A L21-20R, (2)50A CS Type (1)20A L5-20R, (2)20A GFCI
OVERCURRENT PROTECTION	(1) 60A 3-Pole, MCB; (1) 20A 3-Pole, MCB (2) 50A 2-Pole, MCB; (3) 20A 1-Pole, MCB
DIMENSIONS	L 11" W 12" H 25"
WEIGHT	39 lbs.



1

2

3

### 6493061

#### CUSTOM PDU, 60A, 3-PH, 3-Pole, 5-Wire, UL Listed

##### DESCRIPTION

120/208VAC, Three Phase three tier PDU with Input: IEC60309 IP67, 3-Pole, 5 Wire inlet, Output: (1) 60A IEC60309 IP67, 3-Pole 5 Wire receptacle, (2) 30A Twist lock, NEMA L6-30R, 3-Pole 4 Wire receptacles, (2) 30A Twist lock, NEMA L15-30R, 2-Pole 3 Wire receptacles, (8) 20A 5-20 Duplex protected by (1) 60A 3-Pole circuit breaker, (2) 30A 3-Pole circuit breakers, (2) 30A 2-Pole circuit breakers, (8) 20A 1-Pole circuit breakers.

##### SPECIFICATIONS

RATING	60A, 120/208VAC, 3P+N+G
ENVIRONMENTAL RATING	NEMA 3R
INPUT	60A IEC IP67 Inlet
OUTPUT	(1) 60A IEC IP67, (2) 30A L6-30R (2) 30A L15-30R, (8) 20A 5-20 Duplex
OVERCURRENT PROTECTION	(1) 60A 3-Pole, MCB; (2) 30A 3-Pole, MCB (2) 30A 2-Pole, MCB; (8) 20A 1-Pole, MCB
DIMENSIONS	L 11.5" W 12.5" H 25"
WEIGHT	45 lbs.



4

5

6

### 649324CU

#### CUSTOM PDU, 400A, 3-PH, 3-Pole, 4-Wire, UL Listed

##### DESCRIPTION

480VAC, Three Phase three tier PDU with Input: (4) E16 Camlocks, 3-Pole, 4 Wire, Output: (8) 50A CS Type, 3-Pole, 4 wire receptacles with weather cover protected by (8) 50A 3-Pole circuit breakers.

##### SPECIFICATIONS

RATING	400A, 480VAC, 3P+G
ENVIRONMENTAL RATING	NEMA 3R
INPUT	(4) E16 Camlocks, 3P+G
OUTPUT	(8) 50A CS Type, 3P+G Receptacles
OVERCURRENT PROTECTION	(8) 50A 3-Pole, MCB
DIMENSIONS	L 11.5" W 12.5" H 25"
WEIGHT	46 lbs.



7

8

9

10

**649336C35**

**CUSTOM PDU, 360A, 3-PH, 3-Pole, 5 Wire, UL Listed**

**DESCRIPTION**

120/208VAC, Three Phase three tier PDU with Input: (5) E16 Camlocks, 3-Pole, 5 Wire, Output: (5) E15 MINI Camlocks, 3-Pole, 5 Wire, (8) 30A Twist lock, NEMA L21-30R, 3-Pole, 5 Wire receptacles, (3) 20A, 5-20 Duplex protected by (1) 100A 3-Pole circuit breaker, (3) 30A 3-Pole circuit breakers, (15) 30A 1-Pole Circuit breakers, (3) 20A 1-Pole circuit breakers.

**SPECIFICATIONS**

RATING	360A, 120/208VAC, 3P+N+G
ENVIRONMENTAL RATING	NEMA 3R
INPUT	(5) E16 Camlocks, 3P+N+G
OUTPUT	(5) E15 Mini Camlocks, 3P+N+G (8) 30A L21-30R, 3P+N+G (3) 20A 5-20 Duplex
OVERCURRENT PROTECTION	(1) 100A 3-Pole, MCB; (3) 30A 3-Pole, MCB (15) 30A 1-Pole, MCB; (3) 20A 1-Pole, MCB
DIMENSIONS	L 11.5" W 12.5" H 25"
WEIGHT	50 lbs.



**649410I35M**

**CUSTOM PDU, 100A, 3-PH, 3-Pole, 5-Wire**

**DESCRIPTION**

120/208VAC, Three Phase, four tier with Input: (1) 100A IEC60309 IP67, 3-Pole, 5 Wire, Power meter: Power logic PM5110 for measuring voltage & current Output: (1) 60A IEC60309 IP67, 1-Pole, 3 Wire receptacle, (1) 60A Amphenol# MS9055C324112S, 3-Pole, 5 Wire receptacle, (3) 30A Twist lock, L6-30R, 2-Pole, 3 Wire receptacles, (8) 20A 5-20 Duplex receptacles protected by (1) 100A 3-Pole circuit breaker (main), (1) 60A 3-Pole circuit breaker, (1) 60A 1-Pole circuit breaker, (3) 30A 2-Pole circuit breakers, (8) 20A 1-Pole circuit breakers, (1) 0.5A 1-Pole breaker.

**SPECIFICATIONS**

RATING	100A, 120/208VAC, 3P+N+G
ENVIRONMENTAL RATING	indoor use
INPUT	(1) 100A IEC IP67, 3P+N+G, Power meter measuring voltage & current
OUTPUT	(1) 60A IEC IP67, 1P+N+G; (1) 60A Amph.# MS9055C324112S (3) 30A L6-30R, (8) 20A Duplex
OVERCURRENT	(1) 100A 3-Pole, MCB (main) (1) 60A 3-Pole, MCB; (3) 60A 1-Pole, MCB; (3) 30A 2-Pole, MCB; (8) 20A 1-Pole, MCB; (1) 0.5A 1-Pole, MCB
DIMENSIONS	L 12" W 13" H 31". Weight 48 lbs.



**649340C35**

**CUSTOM PDU, 400A, 3-PH, 3-Pole, 5 Wire, UL Listed**

**DESCRIPTION**

415/240VAC, Three Phase three tier PDU with Input: (5) E16 Camlocks, 3-Pole, 5 Wire, Output: (4) 100A IEC60309, IP67, 3-Pole, 5 Wire receptacles protected by (4) 100A 3-Pole molded case circuit breakers.

**SPECIFICATIONS**

RATING	400A, 415/240VAC, 3P+N+G
ENVIRONMENTAL RATING	NEMA 3R
INPUT	(5) E16 Camlocks, 3P+N+G
OUTPUT	(4) 100A IEC60309, IP67, 3P+N+G
OVERCURRENT PROTECTION	(4) 100A 3-Pole, MCCB
DIMENSIONS	L 11.5" W 12.5" H 25"
WEIGHT	52 lbs.



**HEB3102AU**

**CUSTOM PDU, 40A, 3-PH, 3-Pole, 5-Wire, UL Listed**

**DESCRIPTION**

120/208VAC, Three Phase one tier PDU with Input: (5) E16 Camlocks, 3-Pole, 5 Wire, Output: (6) 20A NEMA 5-20 Duplex receptacles with weather cover protected by (6) 20A 1-Pole circuit breakers.

**SPECIFICATIONS**

RATING	40A, 120/208VAC, 3P+N+G
ENVIRONMENTAL RATING	NEMA 3R
INPUT	(5) E16 Camlocks, 3P+N+G
OUTPUT	(6) 20A 5-20R Duplex Rec.
OVERCURRENT PROTECTION	(6) 20A 1-Pole, MCB
DIMENSIONS	L 11.5" W 12.5" H 14"
WEIGHT	19 lbs.



1

2

3

**HEB3105U**

**Custom PDU, 100A, 3-PH, 3-Pole, 5-Wire, UL Listed**

**DESCRIPTION**

120/208VAC, Three Phase double tier PDU with Input: of (5) E16 Camlocks, 3-Pole, 5 Wire, Output: (14) 20A, NEMA 5-20 Duplex GFCI 1-Pole, 3 Wire receptacles with weather cover protected by (14) 20A 1-Pole circuit breaker.

**SPECIFICATIONS**

RATING	100A, 120/208VAC, 3P+N+G
ENVIRONMENTAL RATING	NEMA 3R
INPUT	(5) E16 Camlocks, 3P+N+G
OUTPUT	(14) 20A Duplex GFCI Receptacle
OVERCURRENT PROTECTION	(14) 20A 1-Pole, MCB
DIMENSIONS	L 11.5" W 12.5" H 19"
WEIGHT	35 lbs.



4

5

6

**HEB3106BU**

**Custom PDU, 80A, 3-PH, 3-Pole, 5-Wire, UL Listed**

**DESCRIPTION**

120/208VAC, Three Phase double tier PDU with Input: of (5) E16 Camlocks, 3-Pole, 5 Wire, pass thru: (5) E16 Camlocks, 3-Pole, 5Wire with weather cover, Output: (12) 20A, NEMA 5-20 Duplex, 1-Pole, 3 Wire receptacles with weather cover protected by (12) 20A, 1-Pole circuit breaker.

**SPECIFICATIONS**

RATING	80A, 120/208VAC, 3P+N+G
ENVIRONMENTAL RATING	NEMA 3R
INPUT	(5) E16 Camlocks, 3P+N+G
PASS THRU	(5) E16 Camlocks, 3P+N+G
OUTPUT	(12) 20A 5-20 Duplex Receptacle
OVERCURRENT PROTECTION	(12) 20A 1-Pole, MCB
DIMENSIONS	L 11.5" W 12.5" H 19"
WEIGHT	35 lbs.



7

8

9

10

## SPP3332

### CUSTOM Splitter, 60A, 3-PH, 3-Pole, 4-Wire, UL Listed

#### DESCRIPTION

250V, Three Phase Splitter with Input: (1) 60A IEC60309 IP67, 3-Pole, 4 Wire inlet, Output: (2) 60A IEC60309 IP67, 3-Pole, 4 Wire receptacles.

#### SPECIFICATIONS

RATING	60A, 120/240VAC, 3P+G
ENVIRONMENTAL RATING	NEMA 4x
INPUT	(1) 60A IEC60309 IP67, 3P+G Inlet
OUTPUT	(2) 60A IEC60309 IP67, 3P+G Receptacles
DIMENSIONS	L 16" W 16" H 6.5"
WEIGHT	16 lbs.



## SPP3334

### CUSTOM Splitter, 60A, 3-PH, 3-Pole, 4-Wire, UL Listed

#### DESCRIPTIONS

250V, Three Phase Splitter with Input: (1) 60A IEC60309 IP67, 3-Pole, 4 Wire inlet, Output: (4) 60A IEC60309 IP67, 3-Pole, 4 Wire receptacles.

#### SPECIFICATIONS

RATING	60A, 250VAC, 3P+G
ENVIRONMENTAL RATING	NEMA 4x
INPUT	(1) 60A IEC60309 IP67, 3P+G Inlet
OUTPUT	(4) 60A IEC60309 IP67, 3P+G Receptacles
DIMENSIONS	L 16" W 16" H 6.5"
WEIGHT	18 lbs.







1

2

3

4

5

6

7

8

9

10

**Marinas/ Ship Building and Ship Repair**

**649106I4**

**CUSTOM PDU, 60A, 3-PH, 3-Pole, 4-Wire, UL Listed**

**DESCRIPTION**

480VAC, Three Phase single tier PDU with input: (1) 60A IEC60309 IP67, 3-Pole, 4 Wire, 90° Angled inlet, Output: (3) 30A IEC60309 IP67, 3-Pole, 4 Wire straight receptacles protected by (3) 30A 3-Pole circuit breakers.

**SPECIFICATIONS**

RATING	60A, 480VAC, 3P+G
ENVIRONMENTAL RATING	NEMA 3R
INPUT	(1) 60A IEC IP67, 3P+G Inlet
OUTPUT	(3) 30A IEC IP67, 3P+G Rec.
OVERCURRENT PROTECTION	(3) 30A 3-Pole, MCB
DIMENSIONS	L 11.5" W 12.5" H 14"
WEIGHT	19 lbs.



**649106I34**

**CUSTOM PDU, 60A, 3-PH, 3-Pole, 4-Wire, UL Listed**

**DESCRIPTION**

480VAC, Three Phase single tier PDU with Input: (1) 60A IEC60309 IP67, 3-Pole, 4 Wire, 90° Angled inlet, Output: (3) 30A IEC60309 IP67, 3-Pole, 4 Wire receptacles protected by (3) 25A 3-Pole circuit breakers.

**SPECIFICATIONS**

RATING	60A, 480VAC, 3P+G
ENVIRONMENTAL RATING	NEMA 3R
INPUT	(1) 60A IEC IP67, 3P+G Inlet
OUTPUT	(3) 30A IEC IP67, 3P+G Rec.
OVERCURRENT PROTECTION	(3) 25A 3-Pole, MCB
DIMENSIONS	L 11.5" W 12.5" H 14"
WEIGHT	19 lbs.





## 649110X5

### Custom PDU, 60A, 3-PH, 3-Pole, 4-wire, UL Listed

#### DESCRIPTION

480VAC, Three Phase single tier PDU with Input: (1) 60A, ACP1034CD Plug, 3-Pole, 4 Wire with 10 feet of 6 AWG, 5 Conductor, SOOW cable, Output: (2) 30A NEMA, twist lock L16-30R, 3-Pole, 4 Wire receptacles with weather cover Protected by (2) 30A 3-Pole circuit breakers.

#### SPECIFICATION

RATING	60A, 480VAC, 3P+G
ENVIRONMENTAL RATING	NEMA 3R
INPUT	(1) 100A, ACP1034CD Plug with 10 feet of 4/4 SOOW cord
OUTPUT	(2) 30A L16-30R, 3P+G
OVERCURRENT PROTECTION	(2) 30A 3-Pole, MCB
DIMENSIONS	L 11.5" W 12.5" H 14"
WEIGHT	22 lbs.



1

2

3

## 649110IMN01

### Custom PDU, 100A, 1-PH, 2-Pole, 4-Wire, UL Listed

#### DESCRIPTION

125/250VAC, Single Phase single tier PDU with Input: (1) 100A IEC60309 IP67, 2-Pole, 4 Wire inlet, Output: (2) 50A CS6369 CS Type, 2-Pole, 4 Wire receptacles protected by (2) 50A 2-Pole circuit breakers.

#### SPECIFICATIONS

RATING	100A, 125/208VAC, 2P+N+G
ENVIRONMENTAL RATING	NEMA 3R
INPUT	(1) 100A IEC60309 IP67 Inlet, 2P+N+G
OUTPUT	(2) 50A CS Type, 2P+N+G
OVERCURRENT PROTECTION	(2) 50A 2-Pole, MCB
DIMENSIONS	L 11.5" W 12.5" H 14"
WEIGHT	19 lbs.



4

5

6

7

8

9

10

**Marinas/ Ship Building and Ship Repair**

**649106I3402**

**CUSTOM PDU 60A, 3-PH, 3-Pole, 4 Wire, UL Listed**

**DESCRIPTION**

480VAC, Three Phase single tier PDU with Input: (1) 60A IEC60309 IP67, 3-Pole, 4 Wire, 90°Angled inlet, Output: (2) 30A Meltric, 3-Pole, 4 Wire receptacles protected by (2) 30A 3-Pole circuit breakers.

**SPECIFICATIONS**

RATING	60A, 480VAC, 3P+G
ENVIRONMENTAL RATING	NEMA 3R
INPUT	(1) 60A IEC IP67, 3P+G Inlet
OUTPUT	(2) 30A Meltric Rec., 3P+G
OVERCURRENT PROTECTION	(2) 30A 3-Pole, MCB
DIMENSIONS	L 11.5" W 12.5" H 14"
WEIGHT	19 lbs.



**6492X2M**

**Custom PDU, 100A/480V, 30A/120-208V**

**DESCRIPTION**

Three Phase double tier with Input-1: (1) 100A/480V, Meltric DS100C, 3-Pole, 4 Wire inlet, Output-1: (4) 30A/480V Meltric DS30, 3-Pole, 4 Wire receptacles, Input-2: (1) 30A/208V Meltric DS30 3-Pole, 5 Wire inlet Output-2: (4) 20A 5-20 GFCI Duplex receptacles Protected by (4) 30A 3-Pole circuit breaker, (4) 20A 1-Pole circuit breaker.

**SPECIFICATIONS**

RATING	100A/480V, ~3PH 30A/208V~3PH
ENVIRONMENTAL RATING	NEMA 3R
INPUT 1	100A/480V Meltric 3P+G
OUTPUT 1	(4) 30A/480V Meltric 3P+G
INPUT 2	30A/208V Meltric 3P+N+G
OUTPUT 2	(4) 20A GFCI
OVERCURRENT PROTECTION	(4) 30A, 3-Pole MCB (4) 20A 1-Pole, MCB
DIMENSIONS	L 11.5" W 12.5" H 19"
WEIGHT	33 lbs.



**64920620M**

**Custom PDU, 60A, 1-PH, 2-Pole, 4 Wire**

**DESCRIPTION**

Single Phase double tier PDU with Input: (1) 60A Meltric DS60, 2-Pole, 4 Wire Inlet Output: (8) 20A Duplex GFCI receptacles, with weather cover, (2) 20A NEMA 6-20, 2-Pole, 3 Wire receptacles with weather covers protected by (8) 20A 1-Pole circuit breakers, (2) 20A 2-Pole circuit breakers.

**SPECIFICATIONS**

RATING	60A, 120/208V, 2P+N+G
ENVIRONMENTAL RATING	NEMA 3R
INPUT	(1) 60A Meltric, Inlet, 3P+N+G
OUTPUT	(8) 20A GFCI (2) 20A 6-20R, 2P+G
OVERCURRENT PROTECTION	(8) 20A 1-Pole, MCB (2) 20A 2-Pole, MCB
DIMENSIONS	L 11.5" W 12.5" H 19"
WEIGHT	32 lbs.



## 649230CU

### Custom PDU, 300A, 3-PH, 3-Pole, 5 Wire, UL Listed

#### DESCRIPTION

120/208VAC, Three Phase double tier PDU with Input: (5) E16 Camloks, 3-Pole, 5 Wire, Output: (8) 50A CS Type, 2-Pole, 4 Wire receptacles with weather cover protected by (8) 50A 2-Pole circuit breakers.

#### SPECIFICATIONS

RATING	300A, 120/208VAC, 3P+N+G
ENVIRONMENTAL RATING	NEMA 3R
INPUT	(5) E16 Camloks, 250VAC, 3P+N+G
OUTPUT	(8) 50A CS TYPE, 2P+N+G Receptacles
OVERCURRENT PROTECTION	(8) 50A 2 Pole, MCB
DIMENSIONS	L 11.5" W 12.5" H 19"
WEIGHT	39 lbs.



1

2

3

## 649240CU

### Custom PDU, 400A, 1-PH, 2-Pole, 3-Wire, UL Listed

#### DESCRIPTION

250VAC, Single Phase double tier PDU with Input: (3) E16 Camloks, 2-Pole, 3 Wire, Output: (8) 50A CS Type, 2-Pole, 3 Wire receptacles with weather cover protected by (8) 50A 2-Pole circuit breakers.

#### SPECIFICATIONS

RATING	400A, 250VAC, 2P+G
ENVIRONMENTAL RATING	NEMA 3R
INPUT	(3) E16 Camloks, 250v, 2P+G
OUTPUT	(8) 50A CS Type, 2P+G receptacles
OVERCURRENT PROTECTION	(8) 50A 2-Pole, MCB
DIMENSIONS	L 11.5" W 12.5" H 19"
WEIGHT	39 lbs.



4

5

6

## 649306I34

### Custom PDU, 400A, 3-PH, 3-Pole, 4-Wire, UL Listed

#### DESCRIPTION

480VAC, Three Phase three tier PDU with Input: (1) 60A IEC60309 IP67, 3-Pole, 4 Wire, 90° Angled inlet, Output: (4) 30A IEC60309 IP67, 3-Pole, 4 Wire receptacles protected by (4) 30A 3-Pole circuit breakers.

#### SPECIFICATIONS

RATING	60A, 480VAC, 3P+G
ENVIRONMENTAL RATING	NEMA 3R
INPUT	60A IEC IP67, 90° angled inlet, 3P+G
OUTPUT	(4) 30A IEC IP67, 3P+G Receptacles
OVERCURRENT PROTECTION	(4) 30A 3-Pole, MCB
DIMENSIONS	L 11.5" W 12.5" H 25"
WEIGHT	35 lbs.



7

8

9

10

## Marinas/ Ship Building and Ship Repair

### 649310I

#### CUSTOM PDU, 100A, 3-PH, 3-Pole ,4 Wire, UL Listed

##### DESCRIPTION

480VAC, Three Phase three tier PDU with Input: (1) 100A IEC60309 IP67, 3-Pole 4 Wire inlet, Output: (1) 60A IEC60309 IP67, 3-Pole 4 Wire receptacle, (4) 30A IEC60309 IP67, 3-Pole 4 Wire receptacles protected by (1) 60A 3-Pole circuit breaker, (4) 30A 3-Pole circuit breakers.

##### SPECIFICATIONS

RATING	100A, 480VAC, 3P+G
ENVIRONMENTAL RATING	NEMA 3R
INPUT	(1) 100A IEC IP67, 3P+G
OUTPUT	(1) 60A IEC IP67, 3P+G (4) 30A IEC IP67, 3P+G
OVERCURRENT PROTECTION	(1) 60A 3-Pole, MCB (4) 30A 3-Pole, MCB
DIMENSIONS	L 11.5" W 12.5" H 25"
WEIGHT	42 lbs.



### 649322C

#### CUSTOM PDU, 200A, 3-PH, 3-Pole, 5 Wire, UL Listed

##### DESCRIPTION

120/208VAC, Three Phase three tier PDU with Input: (5) E16 Camlocks, 3-Pole, 5 Wire, Output: (4) 50A CS Type, 2-Pole, 4 Wire receptacles, (2) 30A Twist lock, NEMA L5-30R, 1-Pole 3 Wire receptacles, (4) 20A Duplex GFCI protected by (4) 50A 2-Pole circuit breakers, (2) 30A 1-Pole circuit breakers, (4) 20A 1-Pole circuit breakers.

##### SPECIFICATIONS

RATING	200A, 120/208VAC, 3P+N+G
ENVIRONMENTAL RATING	NEMA 3R
INPUT	(5) E16 Camlocks, 3P+N+G
OUTPUT	(4) 50A CS Type rec.; (2) 30A L5-30R, 1P+N+G (4) 20A Duplex, GFCI
OVERCURRENT PROTECTION	(4) 50A 2-Pole, MCB; (2) 30A 1-Pole, MCB (4) 20A 1-Pole, MCB
DIMENSIONS	L 11.5" W 12.5" H 25"
WEIGHT	45 lbs.



### 649322I

#### CUSTOM PDU 100A 3PH 3 Pole 5 Wire UL Listed

##### DESCRIPTION

120/208VAC, Three Phase three tier PDU with Input: (1) IEC60309 IP67, 3-Pole, 5 Wire inlet , Output: (4) 50A CS Type, 2-Pole 4 Wire receptacles, (2) 30A Twist lock, NEMA L5-30R, 1-Pole 3 Wire receptacles, (4) 20A 5-20 Duplex GFCI protected by (4) 60A 3-Pole circuit breakers, (2) 30A 1-Pole circuit breakers, (4) 20A 1-Pole circuit breakers.

##### SPECIFICATIONS

RATING	100A, 120/208VAC, 3P+N+G
ENVIRONMENTAL RATING	NEMA 3R
INPUT	(1) IEC IP67, 3P+N+G
OUTPUT	(4) 50A CS Type rec.; (2) 30A L5-30R (4) 20A Duplex, GFCI
OVERCURRENT PROTECTION	(4) 50A 2-Pole, MCB; (2) 30A 1-Pole, MCB (4) 20A 1-Pole, MCB
DIMENSIONS	L 11.5" W 12.5" H 25"
WEIGHT	45 lbs.





## HEB362U

### CUSTOM PDU, 40A, 3-PH, 3-Pole, 5-Wire, UL Listed

#### DESCRIPTION

120/208VAC, Three Phase one tier PDU with Input: (1) 60A IEC60309 IP67, 3-Pole, 5 Wire inlet, Output: (6) 20A Duplex GFCI receptacles with weather cover protected by (6) 20A 1-Pole circuit breakers.

#### SPECIFICATIONS

RATING	40A, 120/208VAC, 3P+N+G
ENVIRONMENTAL RATING	NEMA 3R
INPUT	(1) 60A IEC IP67, 3P+N+G Inlet
OUTPUT	(6) 20A Duplex GFCI Rec.
OVERCURRENT PROTECTION	(6) 20A 1-Pole, MCB
DIMENSIONS	L 11.5" W 12.5" H 14"
WEIGHT	19 lbs.



1

2

3

## BK40C34MSB

### CUSTOM PDU, 400A, 3-PH, 3-Pole, 4-Wire

#### DESCRIPTION

480VAC, Three Phase stainless steel power distribution with a modular state of the art enclosure with Input: (4) E16 Camlocks, 3-Pole, 4 Wire, Output: (4) 30A IEC60309 IP67, 3-Pole, 4 Wire, 15° Angled receptacles, (4) 60A IEC60309 IP67, 3-Pole, 4 Wire, 15° Angled receptacles, (2) 100A IEC60309 IP67, 3-Pole, 4 Wire, 15° Angled receptacles protected by (1) 400A 3-Pole disconnect switch (main), (1) 400A 3-Pole main circuit breakers, (4) 30A 3-Pole circuit breakers, (4) 60A 3-Pole circuit breakers, (2) 100A 3-Pole circuit breakers.

#### SPECIFICATIONS

RATING	400A, 480VAC 3P+G
INPUT	(4) E16 Camlok 3P+G
OUTPUT	(4) 30A IEC IP67, 3P+G, 15° Angled; (4) 60A IEC IP67, 3P+G, 15° Angled; (2) 100A IEC IP67, 3P+G, 15° Angled
OVERCURRENT PROTECTION	(1) 400A 3-Pole main disconnect switch (1) 400A 3-Pole, MCB, Main breaker (4) 30A 3-Pole, MCB; (4) 60A 3-Pole, MCB; (2) 100A 3-Pole, MCB
DIMENSIONS	L 17" W 50" H 47"
WEIGHT	700 lbs.



4

5

6

## 65903SPP2

### CUSTOM PDU, 480A, 3-PH, 3-Pole, 4-Wire, UL Listed

#### DESCRIPTION

480V, Three phase plastic enclosure with Input: (1) 30A IEC60309 IP67, 3-Pole, 4 Wire Plug with 2-feet of 8-AWG, 4 Conductor, SOOW cord, Output: (2) 30A IEC60309 IP67, 3-Pole, 4 Wire female connectors with 2-feet of 8-AWG, 4 Conductor, SOOW cord protected by: (1) 30A 3-Pole circuit breaker.

#### SPECIFICATIONS

RATING	30A, 480VAC, 3P+G
ENVIRONMENTAL RATING	NEMA 3R
INPUT	(1) 30A IEC IP67 Plug with 2ft 8/4 SO cord
OUTPUT	(2) 30A IEC IP67 Connector with 2ft 8/4 SO cord
OVERCURRENT PROTECTION	(1) 30A 3-Pole, MCB
DIMENSIONS	L 4.5" W 13" H 8"
WEIGHT	12lbs.



7

8

9

10

**BK40C34MS**

**CUSTOM PDU, 400A, 3-PH, 3-Pole, 4-Wire**

**DESCRIPTION**

360A/480VAC, Three Phase stainless steel power distribution with a modular state of the art enclosure with Input: (4) E16 Camlocks, 3-Pole, 4 Wire, Output: (6) 60A IEC60309, IP67, 3-Pole, 4 Wire, 15°Angled receptacles protected by (1) 400A 3-Pole disconnect switch (main), (6) 60A 3-Pole molded case circuit breakers.

**SPECIFICATIONS**

RATING	360A/480VAC 3P+G
INPUT	(4) E16 Camlok, 3P+G
MAIN DISCONNECT	400A 3-Pole Switch
OUTPUT	(6) 60A IEC, IP67, 3P+G, 15° Angled
OVERCURRENT PROTECTION	(6) 60A 3-Pole MCCB
DIMENSIONS	L 17" W 36" H 47"
WEIGHT	400 lbs.





### 682103TSPWU

#### CUSTOM PDU, 30A, 3-PH, 3-Pole, 4-Wire, UL Listed

##### DESCRIPTION

7.5 KVA Single Phase step down transformer, 480V Primary 120/240 Secondary voltage, Three phase, Input: (1) 30A IEC60309 IP67, 3-Pole, 4 Wire inlet, Output: (1) 20A, 480V IEC60309 IP67, 3-Pole, 4 Wire receptacle, (2) 20A 5-20 Duplex receptacles protected by (1) 20A 3-Pole circuit breaker, (1) 30A 2-Pole circuit breaker, (1) 20A 2-Pole circuit breaker, (2) 20A 1-Pole circuit breakers.

##### SPECIFICATIONS

RATING	30A, 480/120VAC, 3P+G
ENVIRONMENTAL RATING	NEMA 3R
INPUT	(1) 30A IEC IP67, 3P+G Inlet
OUTPUT	(1) 20A IEC IP67, 3P+G (2) 20A 5-20 Duplex
OVERCURRENT PROTECTION	(1) 20A 3-Pole MCB, (1) 30A 2-Pole MCB (1) 20A 2-Pole MCB, (2) 20A 1-Pole MCB
DIMENSIONS	L 16" W 18" H 46"
WEIGHT	125 lbs.



1

2

3

### 682104TSPWU

#### CUSTOM PDU, 30A, 1-PH, 2-Pole, 4-Wire, UL Listed

##### DESCRIPTION

7.5 KVA Single Phase step down transformer, 480V Primary, 120/240 Secondary voltage, Input: (1) 30A IEC60309 IP67, 3-Pole, 4 Wire inlet, Output: (2) 20A 5-20 Duplex, GFCI receptacles protected by (1) 30A 2-Pole circuit breaker, (1) 50A 2-Pole circuit breaker, (4) 20A 1-Pole circuit breakers.

##### SPECIFICATIONS

RATING	30A, 480-120/240VAC, 3P+G
ENVIRONMENTAL RATING	NEMA 3R
INPUT	(1) 30A IEC60309 IP67, 3P+G Inlet
OUTPUT	(4) 20A Duplex, GFCI
OVERCURRENT PROTECTION	(1) 30A 2-Pole, MCB (1) 50A 2-Pole, MCB (4) 20A 1-Pole, MCB
DIMENSIONS	L 16" W 18" H 46"
WEIGHT	125 lbs.



4

5

6

7

NOTE: Color of hand truck may vary

8

9

10

**641203PC3502**

**Custom PDU, 20A, 3-PH, 3-Pole 5-Wire**

**DESCRIPTION**

120/208VAC, Three phase Power distribution unit (PDU) with Input: (1) 20A Twist lock, NEMA L21-30P, 3-Pole, 5 Wire plug with 5-feet of 8-AWG, 5 Conductor SOOW cable, Output: (3) 20A NEMA 5-20R Duplex receptacles Protected by (3) 20A 1 Pole circuit breakers.

**SPECIFICATIONS**

RATING	20A, 120/208VAC, 3P+N+G
ENVIRONMENTAL RATING	indoor use
INPUT	(1) 30A L21-30P Plug, 3P+N+G with 5FT of 10/5 SOOW cable
OUTPUT	(3) 20A, 5-20 Duplex
OVERCURRENT PROTECTION	(3) 20A 1-Pole, MCB
DIMENSIONS	L 25" W 6" H 5"
WEIGHT	11 lbs.



**649103ML01**

**CUSTOM PDU 30A, 3-PH, 3-Pole, 5-Wire, UL Listed**

**DESCRIPTION**

120/208VAC, Three Phase single tier with Input: (1) 30A Twist lock NEMA L21-30R, 3-Pole, 5 Wire inlet with phase indicators light, Output: (6) 20A GFCI Duplex receptacles protected by (6) 20A 1-Pole circuit breakers.

**SPECIFICATIONS**

RATING	30A, 120/208VAC, 3P+N+G
ENVIRONMENTAL RATING	NEMA 3R
INPUT	30A L21-30 Inlet, 3P+N+G with indicators light
OUTPUT	(6) 20A GFCI Duplex
OVERCURRENT PROTECTION	(6) 20A 1-Pole, MCB
DIMENSIONS	L 11" W 12" H 14"
WEIGHT	19 lbs.



**649103N5 with ground lug**

**CUSTOM PDU, 30A, 3-PH, 3-Pole, 5-Wire, UL Listed**

**DESCRIPTION**

120/208VAC, Three Phase single tier with Input: (1) 30A twist lock NEMA L21-30, 3-Pole, 5 Wire inlet, Pass thru: (1) 30A twist lock NEMA L21-30, 3-Pole, 5 wire receptacle, Output: (3) 20A GFCI Duplex receptacles protected by (3) 20A 1-Pole circuit breakers.

**SPECIFICATIONS**

RATING	30A, 120/208VAC, 3P+N+G
ENVIRONMENTAL RATING	NEMA 3R
INPUT	(1) 30A L21-30 Inlet, 3P+N+G
PASS THRU	(1) 30A L21-30R 3P+N+G
OUTPUT	(3) 20A GFCI Duplex
OVERCURRENT PROTECTION	(3) 20A 1-Pole, MCB
DIMENSIONS	L 11" W 12" H 14"
WEIGHT	19 lbs.



**649103N5**

**CUSTOM PDU, 30A, 3-PH, 3-Pole, 5-Wire, UL Listed**

**DESCRIPTION**

120/208VAC, Three Phase single tier with Input: (1) 30A twist lock NEMA L21-30, 3-Pole, 5 Wire inlet, Pass thru: (1) 30A twist lock NEMA L21-30, 3-Pole, 5 wire receptacle, Output: (3) 20A GFCI Duplex receptacles protected by (3) 20A 1-Pole circuit breakers.

**SPECIFICATIONS**

RATING	30A, 120/208VAC, 3P+N+G
ENVIRONMENTAL RATING	NEMA 3R
INPUT	(1) 30A L21-30 Inlet, 3P+N+G
PASS THRU	(1) 30A L21-30R 3P+N+G
OUTPUT	(3) 20A GFCI Duplex
OVERCURRENT PROTECTION	(3) 20A 1-Pole, MCB
DIMENSIONS	L 11" W 12" H 14"
WEIGHT	19 lbs.



1

2

3

**649103N3502**

**Custom PDU, 30A, 3-PH, 3-Pole, 5-Wire UL Listed**

**DESCRIPTION**

120/208VAC, Three Phase single tier with Input: 30A Twist lock NEMA L21-30 3-Pole 5 Wire inlet with weather cover, Output: (1) 30A twist lock NEMA L15-30R 3-Pole 4 Wire receptacle with weather cover, (1) 30A NEMA 6-30R, 2-Pole, 3 Wire receptacle with weather cover, (3) 20A GFCI Duplex with weather cover Protected by (1) 30A 3-Pole circuit breaker, (1) 30A 2-Pole circuit breakers, (3) 20A 1-Pole circuit breakers.

**SPECIFICATIONS**

RATING	30A, 120/208VAC, 3P+N+G
ENVIRONMENTAL RATING	NEMA 3R
INPUT	30A L21-30 Inlet
OUTPUT	(1) 30A L15-30R, 3P+G, (1) 30A 6-30R, 2P+G (3) 20A Duplex GFCI
OVERCURRENT PROTECTION	(1) 30A 3-Pole, MCB, (1) 30A 2-Pole, MCB (3) 20A 1-Pole, MCB
DIMENSIONS	L 11" W 12" H 14"
WEIGHT	15 lbs.



4

5

6

**649106CP5**

**Custom PDU, 60A, 3-PH, 3-Pole, 5-wire, UL Listed**

**DESCRIPTION**

120/208VAC, Three Phase single tier with Input: 60A IEC60309 IP67, Plug 3-Pole 5 Wire with 6 feet of 6 AWG 5 Conductor Type W cable, Output: (2) 30A NEMA twist lock L21-30R 3-Pole 5 Wire receptacles with weather cover Protected by (2) 30A 3-Pole circuit breakers.

**SPECIFICATIONS**

RATING	60A, 120/208VAC, 3P+N+G
ENVIRONMENTAL RATING	NEMA 3R
INPUT	(1) 60A IEC IP67, Plug with 6 feet of 6/5 TYPE W cable
OUTPUT	(2) 30A L21-30R, 3P+N+G
OVERCURRENT PROTECTION	(2) 30A 3-Pole, MCB
DIMENSIONS	L 11.5" W 12.5" H 14"
WEIGHT	22 lbs.



7

8

9

10

## Entertainment, Convention Centers, Trade Shows, & Sporting Events

### 649106CPC

#### Custom PDU, 60A, 3-PH, 3-Pole, 5-Wire, UL Listed

##### DESCRIPTION

120/208VAC, Three Phase single tier with Input: (5) E16 Camlocks, 3-Pole, 5 wire with 3 feet of 4 AWG 5 Conductor SOOW cable, Output: (2) 30A NEMA twist lock, L21-30R, 3-Pole, 5 wire receptacles Protected by (2) 30A 3-Pole circuit breakers.

##### SPECIFICATIONS

RATING	60A, 120/208VAC, 3P+N+G
ENVIRONMENTAL RATING	indoor use
INPUT	(5) E16 Camlocks with 3 feet of 4/5 SOOW cable, 3P+N+G
OUTPUT	(2) 30A L21-30R, 3P+N+G
OVERCURRENT PROTECTION	(2) 30A 3-Pole, MCB
DIMENSIONS	L 11.5" W 12.5" H 14"
WEIGHT	19 lbs.



### 649106CV1

#### Custom PDU, 60A, 3-PH, 3-Pole, 5-Wire UL Listed

##### DESCRIPTION

120/208VAC, Three Phase single tier with Input: (5) E16 Camlocks, 3-Pole, 5 Wire, Output: (2) 20A twist lock, NEMA L15-20R, 3-Pole, 4 Wire receptacles, (1) 20A Duplex GFCI Protected by (2) 20A 3-Pole circuit breakers, (1) 20A 1-Pole circuit breaker.

##### SPECIFICATIONS

RATING	60A, 120/208VAC, 3P+N+G
ENVIRONMENTAL RATING	indoor use
INPUT	(5) E16 Camlocks, 3P+N+G
OUTPUT	(2) 20A L15-20R, 3P+G (1) 20A Duplex GFCI
OVERCURRENT PROTECTION	(2) 20A 3-Pole, MCB (1) 20A 1-Pole, MCB
DIMENSIONS	L 11" W 12" H 14"
WEIGHT	15 lbs.



### 649108CV1

#### Custom PDU, 60A, 3-PH, 3-Pole, 5-Wire UL Listed

##### DESCRIPTION

120/208VAC, Three Phase, single tier with Input: (5) E16 Camlocks, 3-Pole, 5 Wire, Output: (2) 20A twist lock, NEMA L15-20R, 3-Pole, 4 Wire receptacles, (1) 20A Duplex GFCI receptacle Protected by (2) 20A 3-Pole circuit breakers, (1) 20A 1-Pole circuit breaker.

##### SPECIFICATIONS

RATING	60A, 120/208VAC, 3P+N+G
ENVIRONMENTAL RATING	indoor use
INPUT	(5) E16 Camlocks, 3P+N+G
OUTPUT	(2) 20A L15-20R, 3P+G (1) 20A Duplex GFCI
OVERCURRENT PROTECTION	(2) 20A 3-Pole, MCB (1) 20A 1-Pole, MCB
DIMENSIONS	L 11" W 12" H 14"
WEIGHT	16 lbs.





**649110CPC13**

**CUSTOM PDU 100A, 1-PH, 1-Pole, 3-Wire, UL Listed**

**DESCRIPTION**

120VAC, Single Phase single tier PDU with Input: (3) E16 Camlocks, 1-Pole, 3 Wire with 10 feet, 4 AWG, 3 Conductor Type W cable, Output: (2) 30A Twist lock, NEMA L5-30R, 1-Pole, 3 Wire receptacles, (2) 20A 5-20, Duplex receptacles protected by (2) 30A 1-Pole circuit breakers, (2) 20A 1-Pole circuit breakers.

**SPECIFICATIONS**

RATING	100A, 120VAC, 1P+N+G
ENVIRONMENTAL RATING	indoor use
INPUT	(3) E16 Camlocks, 1P+N+G with 10FT, 4/3C Type W
OUTPUT	(2) 30A L5-30R 1P+N+G Rec. (2) 20A 5-20 Duplex Rec.
OVERCURRENT PROTECTION	(2) 30A 1-Pole, MCB (2) 20A 1-Pole, MCB
DIMENSIONS	L 11.5" W 12.5" H 14"
WEIGHT	20 lbs.



1

2

3

**649204ML01**

**Custom PDU 40A, 3-PH, 3-Pole, 5-Wire, UL Listed**

**DESCRIPTION**

120/208VAC, Three Phase double tier with Input: (5) E16 Camlocks, 3-Pole, 5 Wire, Pass thru: (5) E16 camlocks, 3-Pole 5 Wire with wither cover, Output: (6) 20A Duplex GFCI receptacles with weather cover Protected by (6) 20A 1-Pole circuit breakers.

**SPECIFICATIONS**

RATING	40A, 120/208VAC, 3P+N+G
ENVIRONMENTAL RATING	NEMA 3R
INPUT	(5) E16 Camlocks, 3P+N+G
PASS THRU	(5) E16 Camlocks, 3P+N+G
OUTPUT	(2) 20A Duplex, GFCI
OVERCURRENT PROTECTION	(6) 20A 1 Pole, MCB
DIMENSIONS	L 11.5" W 12.5" H 19"
WEIGHT	34 lbs.



4

5

6

**649206I35**

**Custom PDU, 60A, 3-PH, 3-Pole, 5 Wire, UL Listed**

**DESCRIPTION**

120/208VAC, Three Phase double tier PDU with Input: (1) 60A IEC60309, IP67, 3-Pole, 5 Wire 90° Angled Inlet Output: (8) 20A NEMA 5-20 Single receptacle, 1-Pole, 3 Wire receptacles with weather cover protected by (8) 20A 1-Pole circuit breakers.

**SPECIFICATIONS**

RATING	60A, 120/208VAC, 3P+N+G
ENVIRONMENTAL RATING	NEMA 3R
INPUT	(1) 60A IEC60309, IP67 90° Inlet, 3P+N+G
OUTPUT	(8) 20A 5-20 Single Receptacles
OVERCURRENT PROTECTION	(8) 20A 1-Pole, MCB
DIMENSIONS	L 11.5" W 12.5" H 19"
WEIGHT	39 lbs.



7

8

9

10

**Entertainment, Convention Centers, Trade Shows, & Sporting Events**

**649210PC**

**Custom PDU, 100A, 3-PH, 3-Pole, 5-Wire, UL Listed**

**DESCRIPTION**

240/400VAC, Three Phase double tier with Input: (1) 100A IEC60309 IP67, 3-Pole, 5 Wire plug with 3 Meter of 2 AWG, 5 Conductor SOOW cable, Pass thru: (1) 100A IEC309 IP67 3Pole 5wire receptacle, Output: (3) 32A IEC60309 IP67, 3-Pole, 5 Wire, 15°angled receptacles, Protected by (3) 32A 3-Pole circuit breaker.

**SPECIFICATIONS**

RATING	100A, 240/400VAC, 3P+N+G
ENVIRONMENTAL RATING	NEMA 3R
INPUT	100A IEC IP67, Plug with 3 meters of 2/5C SOOW cable
PASS THRU	(1) 100A IEC IP67, 3P+N+G
OUTPUT	(3) 32A IEC IP67, 15°angled 3P+N+G
OVERCURRENT PROTECTION	(3) 32A 3 Pole, MCB
DIMENSIONS	L 11.5" W 12.5" H 19"
WEIGHT	36 lbs.



**649213CC3501**

**Custom PDU, 130A, 3-PH, 3-Pole, 5-Wire, UL Listed**

**DESCRIPTION**

120/208VAC, Three Phase double tier with Input: (5) E16 Camlocks, 3-Pole, 5 Wire, Pass thru: (5) E16 Camlocks, 3-Pole, 5 Wire with weather cove, Output: (3) 30ATwist lock, NEMA L21-30R, 3-Pole, 5 Wire receptacles with weather cover, (6) 20A Duplex GFCI with weather cover protected by, (3) 30A 3-Pole circuit breakers, (6) 20A 1-Pole circuit breakers.

**SPECIFICATIONS**

RATING	130A, 120/208VAC, 3P+N+G
ENVIRONMENTAL RATING	NEMA 3R
INPUT	(5) E16 Camlocks, 3P+N+G
PASS THRU	(5) E16 Camlocks, 3P+N+G
OUTPUT	(3) 30A L21-30R, 3P+N+G; (6) 20A Duplex GFCI
OVERCURRENT PROTECTION	(3) 30A 3-Pole, MCB; (6) 20A 1-Pole, MCB
DIMENSIONS	L 11.5" W 12.5" H 19"
WEIGHT	34 lbs.



**649215C3502**

**CUSTOM PDU, 140A, 3-PH, 3-Pole, 5 Wire, UL Listed**

**DESCRIPTION**

120/208VAC, Three Phase double tier PDU with Input: (5) E16 Camlocks, 3-Pole, 5 Wire, Output: (4) 30A IEC60309, IP44, 3-Pole, 5 Wire receptacles, (3) 20A 5-20 Duplex receptacles protected by (4) 30A 3-Pole circuit breakers, (3) 20A 1-Pole circuit breaker.

**SPECIFICATIONS**

RATING	140A, 120/208VAC 3P+N+G
ENVIRONMENTAL RATING	NEMA 3R
INPUT	(5) E16 Camlocks, 3P+N+G
OUTPUT	(4) 30A IEC, IP44, 3P+N+G (3) 20A 5-20 Duplex
OVERCURRENT PROTECTION	(4) 30A 3-Pole, MCB (3) 20A 1-Pole, MCB
DIMENSIONS	L 11" W 12" H 25"
WEIGHT	32 lbs.





### 649217C35

#### CUSTOM PDU, 170A, 3-PH, 3-Pole, 5 Wire, UL Listed

##### DESCRIPTION

120/208VAC, Three Phase double tier PDU with Input: (5) E16 Camlocks, 3-Pole, 5 Wire, Output: (5) 30A Twist lock, NEMA L21-30R, 3-Pole, 5 Wire receptacles, (3) 20A 5-20 Duplex receptacles protected by (5) 30A 3-Pole circuit breakers, (3) 20A 1-Pole circuit breaker.

##### SPECIFICATIONS

RATING	170A, 120/208VAC, 3P+N+G
ENVIRONMENTAL RATING	NEMA 3R
INPUT	(5) E16 Camlocks, 3P+N+G
OUTPUT	(5) 30A L21-30R, 3P+N+G. (3) 20A 5-20 Duplex
OVERCURRENT PROTECTION	(5) 30A 3-Pole, MCB (3) 20A 1-Pole, MCB
DIMENSIONS	L 11" W 12" H 25"
WEIGHT	32 lbs.



1

2

3

### 649218C35

#### CUSTOM PDU, 150A, 3-PH, 3-Pole, 5 Wire, UL Listed

##### DESCRIPTION

120/250VAC, Three Phase double tier with Input: (5) E15 Mini Camlocks, 3-Pole 5 Wire, Output: (6) 30A Twist lock, NEMA L21-30R, 3-Pole, 5 Wire receptacles protected by (6) 30A 3-Pole circuit breakers.

##### SPECIFICATIONS

RATING	150A, 120/208VAC, 3P+N+G
ENVIRONMENTAL RATING	indoor use
INPUT	(5) E15 Camlocks, 3P+N+G
OUTPUT	(6) 30A L21-30R, 3P+N+G.
OVERCURRENT PROTECTION	(6) 30A 3-Pole, MCB
DIMENSIONS	L 11" W 12" H 25"
WEIGHT	30 lbs.



4

5

6

### 649224CC35

#### Custom, PDU, 240A, 3-PH, 3-Pole, 5-Wire, UL Listed

##### DESCRIPTION

120/208VAC, Three Phase double tier PDU with Input: (5) E16 Camlocks, 3-Pole, 5 Wire with (3) 120v, indicators light for each phase, Pass thru: (5) E16 camlocks, 3-Pole 5 Wire with weather cover, Output: (4) 60A IEC IP67, 3-Pole, 5 Wire receptacles Protected by (4) 60A, 3-Pole circuit breakers.

##### SPECIFICATIONS

RATING	240A, 120/208VAC, 3P+N+G
ENVIRONMENTAL RATING	NEMA 3R
INPUT	(5) E16 Camlocks, 3P+N+G
PASS THRU	(5) E16 Camlocks, 3P+N+G
OUTPUT	(4) 60A IEC IP67, 3P+N+G
OVERCURRENT PROTECTION	(4) 60A 3-Pole, MCB
DIMENSIONS	L 11.5" W 12.5" H 19"
WEIGHT	35 lbs.



7

8

9

10

## Entertainment, Convention Centers, Trade Shows, & Sporting Events

### HEB201X2U

#### “Off-the-Shelf” PDU, 50A, 1-PH, 2-Pole, 4-Wire, UL Listed

##### DESCRIPTION

120/208VAC, Single Phase one tier PDU with Input: (1) 50A Twist lock, CS6375, 2-Pole, 4 Wire inlet, Output: (1) 50A 14-50R, 2-Pole, 4 Wire Receptacle, (6) 20A NEMA 5-20R Duplex with weather cover receptacles protected by (1) 50A 2-Pole circuit breaker, (6) 20A 1-Pole circuit breakers.

##### SPECCIFICATIONS

RATING	50A, 120/208VAC, 2P+N+G
ENVIRONMENTAL RATING	indoor use
INPUT	(1) 50A CS Type 2P+N+G Inlet
OUTPUT	(1) 50A 14-50R Receptacle (6) 20A 5-20R Duplex
OVERCURRENT PROTECTION	(1) 50A 2-Pole, MCB (Main) (6) 20A 1-Pole, MCB
DIMENSIONS	L 11.5” W 12.5” H 14”
WEIGHT	19 lbs.



### HEB202UA

#### “Off-the-Shelf” PDU, 50A, 1-PH, 2-Pole, 4-Wire, UL Listed

##### DESCRIPTION

120/208VAC, Single Phase one tier PDU with Input: (1) 50A Twist lock, CS6375, 2-Pole, 4 Wire inlet, Passthru: (1) 50A NEMA 14-50R, 2-Pole, 4 Wire receptacle, Output: (1) 30A Twist lock, L6-30R, 2-Pole, 3 Wire receptacle, (3) 20A, 5-20 Duplex GFCI receptacles protected by (1) 50A 2-Pole circuit breaker, (1) 30A 2-Pole circuit breakers, (3) 20A 1-Pole circuit breakers.

##### SPECIFICATIONS

RATING	50A, 120/208VAC, 2P+N+G
ENVIRONMENTAL RATING	indoor use
INPUT	(1) 50A CS Type, 2P+N+G Inlet
PASS THRU	(1) 50a 14-50R 2P+N+G
OUTPUT	(1) 30A L6-20R, 2P+G Rec., (3) 20A 5-20 Duplex GFCI
OVERCURRENT PROTECTION	(1) 50A 2-Pole, MCB (Main), (2) 30A 2-Pole, MCB (3) 20A 1-Pole, MCB
DIMENSIONS	L 11.5” W 12.5” H 14”
WEIGHT	18 lbs.



### HEB203AU

#### CUSTOM PDU, 50A, 1-PH, 2-Pole, 4-Wire, UL Listed

##### DESCRIPTION

120/208VAC, Single Phase one tier PDU with Input: (1) 50A Twist lock, CS6375, 2-Pole, 4 Wire inlet, Output: (1) 50A Twist lock, CS6369 2-Pole, 4 Wire receptacle, (2) 30A Twist lock, L6-30R, 2-Pole, 3 Wire receptacles, (3) 20A, 5-20 Duplex receptacles protected by (1) 50A 2-Pole circuit breaker, (2) 30A 2-Pole circuit breakers, (3) 20A 1-Pole circuit breakers.

##### SPECIFICATIONS

RATING	50A, 120/208VAC, 2P+N+G
ENVIRONMENTAL RATING	NEMA 3R
INPUT	(1) 50A CS Type, 2P+N+G Inlet
OUTPUT	(1) 50A CS Type, 2P+N+G Rec. (2) 30A L6-20R, 2P+G Rec., (3) 20A 5-20 Duplex
OVERCURRENT PROTECTION	(1) 50A 2-Pole, MCB (Main) (2) 30A 2-Pole, MCB, (3) 20A 1-Pole, MCB
DIMENSIONS	L 11.5” W 12.5” H 14”
WEIGHT	19 lbs.



**HEB363SCU**

**“Off-the-Shelf” PDU, 80A, 3-PH, 3-Pole, 5-Wire, UL Listed**

**DESCRIPTION**

120/208VAC, Three Phase single tier PDU with Input: (5) E16 Camlocks, 3-Pole, 5 Wire, Output: (2) 30A Twist lock, NEMA L21-30R, 3-Pole, 5 Wire receptacles, (2) 20A 5-20, Duplex receptacles protected by (2) 30A 3-Pole circuit breakers, (2) 20A 1-Pole circuit breakers.

**SPECIFICATIONS**

RATING	80A, 120/208VAC, 3P+N+G
ENVIRONMENTAL RATING	indoor use
INPUT	(5) E16 Camlocks, 3P+N+G
OUTPUT	(2) 30A L21-30R, 3P+N+G Rec. (2) 20A 5-20 Duplex Rec.
OVERCURRENT PROTECTION	(2) 30A 3-Pole, MCB (2) 20A 1-Pole, MCB
DIMENSIONS	L 11.5” W 12.5” H 14”
WEIGHT	19 lbs.



1

2

3

**HEB1101**

**“Off-the-Shelf” PDU, 100A, 1-PH, 1-Pole, 3-Wire, UL Listed**

**DESCRIPTION**

120 VAC, Single Phase one tier PDU with Input: (1) 100A Stage pin, 1-Pole, 3 Wire inlet, Pass thru: (1) 100A Stage pin, 1-Pole, 3 Wire receptacle, Output: (6) 20A NEMA 5-20R Duplex receptacles protected by (6) 20A 1-Pole circuit breakers.

**SPECIFICATIONS**

RATING	100A, 120VAC, 1P+N+G
ENVIRONMENTAL RATING	indoor use
INPUT	(1) 100A Stage pin, 1P+N+G Inlet
PASS THRU	(1) 100A Stage Pin, 1P+N+G Receptacle
OUTPUT	(6) 20A 5-20R Duplex
OVERCURRENT PROTECTION	(6) 20A 1-Pole, MCB
DIMENSIONS	L 11” W 12” H 14”
WEIGHT	18 lbs.



4

5

6

**HEB3102U**

**“Off-the-Shelf” PDU, 40A, 3-PH, 3-Pole, 5-Wire, UL Listed**

**DESCRIPTION**

120/208VAC, Three Phase one tier PDU with Input: (5) E16 Camlocks, 3-Pole, 5 Wire, Output: (6) 20A Duplex GFCI receptacles with weather cover protected by (6) 20A 1-Pole circuit breakers.

**SPECIFICATIONS**

RATING	40A, 120/208VAC, 3P+N+G
ENVIRONMENTAL RATING	NEMA 3R
INPUT	(5) E16 Camlocks, 3P+N+G
OUTPUT	(6) 20A Duplex GFCI Rec.
OVERCURRENT PROTECTION	(6) 20A 1-Pole, MCB
DIMENSIONS	L 11.5” W 12.5” H 14”
WEIGHT	19 lbs.



7

8

9

10

**Entertainment, Convention Centers, Trade Shows, & Sporting Events**

**HEB3104U**

**CUSTOM PDU, 80A, 3-PH, 3-Pole, 5-Wire, UL Listed**

**DESCRIPTION**

120/208VAC, Three Phase one tier PDU with Input: (5) E16 Camlocks, 3-Pole, 5 Wire, Output: (2) 30A Twist lock, NEMA L21-30R, 3-Pole, 5 Wire with weather cover, receptacles, (3) 20A Duplex GFCI receptacles with weather cover protected by (2) 3-Pole circuit breakers, (3) 20A 1-Pole circuit breakers.

**SPECIFICATIONS**

RATING	80A, 120/208VAC, 3P+N+G
ENVIRONMENTAL RATING	NEMA 3R
INPUT	(5) E16 Camlocks, 3P+N+G
OUTPUT	(2) 30A L21-30R Rec. (3) 20A Duplex GFCI
OVERCURRENT PROTECTION	(2) 30A 3-Pole, MCB (3) 20A 1-Pole, MCB
DIMENSIONS	L 11" W 12" H 14"
WEIGHT	19 lbs.



**HEB3106U**

**Custom PDU 80A, 3-PH, 3-Pole, 5-Wire, UL Listed**

**DESCRIPTION**

120/208VAC, Three Phase double tier PDU with Input: of (5) E16 Camlocks, 3-Pole, 5 Wire, pass thru: (5) E16 Camlocks, 3-Pole, 5Wire with weather cover, Output: (12) 20A, NEMA 5-20 Duplex GFCI , 1-Pole, 3 Wire receptacles with weather cover protected by (12) 20A, 1-Pole circuit breakers.

**SPECIFICATIONS**

RATING	120/208VAC, Three Phase double tier PDU
INPUT	(5) E16 Camlocks, 3-Pole, 5 Wire,
PASS THRU	(5) E16 Camlocks, 3-Pole, 5Wire w/weather cover
OUTPUT	(12) 20A, NEMA 5-20 Duplex GFCI , 1-Pole, 3 Wire
repectacles	
OVERCURRENT PROTECTION	(12) 20A, 1-Pole circuit breakers.



**HEB32601**

**Custom PDU, 60A, 3-PH, 3-Pole, 5-Wire, UL Listed**

**DESCRIPTION**

120/208VAC, Three Phase double tier PDU with Input: of (1) 60A IEC60309 IP67, 3-Pole, 5 Wire inlet, Output: (4) 30A Twist lock, NEMA L21-30R, 3-Pole, 5 Wire receptacles, protected by (4) 30A 3-Pole circuit breaker.

**SPECIFICATIONS**

RATING	60A, 120/208VAC, 3P+N+G
ENVIRONMENTAL RATING	indoor use
INPUT	(1)60A IEC IP67, 3P+N+G
OUTPUT	(4) 30A L21-30R, 3P+N+G Receptacle
OVERCURRENT PROTECTION	(4) 30A 3-Pole, MCB
DIMENSIONS	L 11.5" W 12.5" H 19"
WEIGHT	32 lbs.





**HEBE113S1**

**CUSTOM PDU, 100A, 1-PH, 1-Pole, 3-Wire, UL Listed**

**DESCRIPTION**

120 VAC, Single Phase one tier PDU with Input: (1) 100A Stage pin, 1-Pole, 3 Wire inlet, with indicator light Pass thru: (1) 100A Stage pin, 1-Pole, 3 Wire receptacle, Output: (6) 20A NEMA 5-20R Duplex with weather cover receptacles protected by (6) 20A 1-Pole circuit breakers.

**SPECIFICATIONS**

RATING	100A, 120VAC, 1P+N+G
ENVIRONMENTAL RATING	indoor use
INPUT	(1) 100A Stage pin, 1P+N+G Inlet
PASS THRU	(1) 100A Stage Pin, 1P+N+G Receptacle
OUTPUT	(6) 20A 5-20R Duplex
OVERCURRENT PROTECTION	(6) 20A 1-Pole, MCB
DIMENSIONS	L 11" W 12" H 14"
WEIGHT	18 lbs.



**HEBE113S2**

**CUSTOM PDU, 100A, 1-PH, 1-Pole, 3-Wire, UL Listed**

**DESCRIPTION**

120 VAC, Single Phase one tier PDU with Input: (1) 100A Stage pin, 1-Pole, 3 Wire inlet, with indicator light Pass thru: (1) 100A Stage pin, 1-Pole, 3 Wire receptacle, Output: (6) 20A NEMA 5-20R Duplex receptacles protected by (6) 20A 1-Pole circuit breakers.

**SPECIFICATIONS**

RATING	100A, 120VAC, 1P+N+G
ENVIRONMENTAL RATING	indoor use
INPUT	(1) 100A Stage pin, 1P+N+G Inlet
PASS THRU	(1) 100A Stage Pin, 1P+N+G Receptacle
OUTPUT	(6) 20A 5-20R Duplex
OVERCURRENT PROTECTION	(6) 20A 1-Pole, MCB
DIMENSIONS	L 11" W 12" H 14"
WEIGHT	18 lbs.

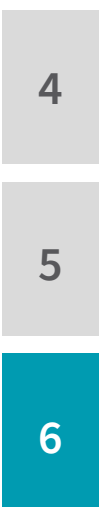

**HEBE135N1**

**CUSTOM PDU 20A, 3-PH, 3-Pole, 5 Wire**

**DESCRIPTION**

125/250VAC, Three Phase single tier PDU with Input: (1) 20A Twist lock NEMA L21-20R, 3-Pole, 5 Wire inlet, (1) DMX Inlet, Pass thru: (1) DMX Outlet, Output: (4) DMX Outlet, (6) Powercon true Outlet protected by (1) 20A 3-Pole circuit breakers, (1) 0.5A 1-Pole circuit breaker.

**SPECIFICATIONS**

RATING	20A, 120/208VAC, 3P+N+G
ENVIRONMENTAL RATING	indoor use
INPUT	(1) 20A L21-20R, (1) DMX Inlet
PASS THRU	(1) DMX Outlet
OUTPUT	(6) Powercon True (4) DMX Outlet
OVERCURRENT PROTECTION	(1) 20A 3-Pole, MCB (1) 0.5A 1-Pole, MCB
DIMENSIONS	L 11" W 12" H 14"
WEIGHT	16 lbs.

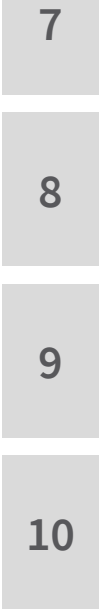



## Entertainment, Convention Centers, Trade Shows, & Sporting Events

### HEBE235C1

#### CUSTOM PDU 80A, 3-PH, 3-Pole, 5 Wire

##### DESCRIPTION

120/208VAC, Three Phase, Double tier PDU, DMX & Splitter Power with Input: (5) E16 camlocks 3-Pole, 5 Wire, (1) DMX Inlet, Output: (4) DMX Outlet, (6) Powercon true Outlet, (6) 20A NEMA 5-20 Receptacle in parallel with socapex, (1) Socapex 419 female panel mount protected by (12) 20A 1-Pole circuit breakers, (1) 0.5A 1-Pole circuit breaker.

##### SPECIFICATIONS

RATING	80A, 120/208VAC, 3P+N+G
ENVIRONMENTAL RATING	indoor use
INPUT	(5) E16 Camlocks, (1) DMX Inlet
OUTPUT	(6) 20A 5-20 Single receptacles (6) Powercon True (4) DMX Outlet (1) Socapex 419
OVERCURRENT PROTECTION	(12) 20A 1-Pole, MCB; (1) 0.5A 1-Pole, MCB
DIMENSIONS	L 11" W 12" H 19"
WEIGHT	32 lbs.



### HEBE235C2

#### CUSTOM PDU 80A, 3-PH, 3-Pole, 5 Wire

##### DESCRIPTION

120/208VAC, Three Phase double tier PDU with Input: (5) E16 camlocks, 3-Pole, 5 Wire, Pass thru: (5) E16 camlocks, 3-Pole, 5 Wire with weather cover, Output: (12) 20A NEMA 5-20 Single Receptacles in parallel with socapex, (2) Socapex 419 female panel mount protected by (12) 20A 1-Pole circuit breakers.

##### SPECIFICATIONS

RATING	80A, 120/208VAC, 3P+N+G
ENVIRONMENTAL RATING	indoor use
INPUT	(5) E16 Camlocks, 3P+N+G
PASS THRU	(5) E16 Camlocks, 3P+N+G
OUTPUT	(12) 20A 5-20 Single receptacles (2) Socapex 419
OVERCURRENT PROTECTION	(12) 20A 1-Pole, MCB
DIMENSIONS	L 11" W 12" H 14"
WEIGHT	31 lbs.



### HEBE235C3

#### CUSTOM PDU 240A, 3-PH, 3-Pole, 5 Wire

##### DESCRIPTION

120/208VAC, Three Phase, Double tier with Input: (5) E16 camlocks, 3-Pole, 5 Wire, Output: (6) 100A Stage pin, 1-Pole, 3 Wire female Panel mount, (4) 20A NEMA 5-20 Duplex Receptacles protected by (6) 100A 1-Pole circuit breakers, (4) 20A 1-Pole circuit breakers.

##### SPECIFICATIONS

RATING	240A, 120/208VAC, 3P+N+G
ENVIRONMENTAL RATING	indoor use
INPUT	(5) E16 Camlocks, 3P+N+G
OUTPUT	(6) 100A, Stage pin, 1P+N+G (4) 20A 5-20R Duplex
OVERCURRENT PROTECTION	(6) 100A 1-Pole, MCB (4) 20A 1-Pole, MCB
DIMENSIONS	L 11" W 12" H 19"
WEIGHT	37 lbs.



### HEBE235C5

#### CUSTOM PDU 160A, 3-PH, 3-Pole, 5 Wire

##### DESCRIPTION

120/208VAC, Three Phase double tier PDU with Input: (5) E16 camlocks, 3-Pole, 5 Wire, Output: (4) Socapex 419 female panel mount protected by (24) 20A 1-Pole circuit breakers.

##### SPECIFICATIONS

RATING	160A, 120/208VAC, 3P+N+G
ENVIRONMENTAL RATING	indoor use
INPUT	(5) E16 Camlocks, 3P+N+G
OUTPUT	(4) Socapex 419
OVERCURRENT PROTECTION	(24) 20A 1-Pole, MCB
DIMENSIONS	L 11" W 12" H 14"
WEIGHT	31 lbs.



1

2

3

### 68107CS

#### CUSTOM Switch Enclosure, 125A, 3-PH, 3-Pole, 5-Wire

##### DESCRIPTION

120/208V, Three Phase switch enclosure with Input: (1) Hard wire by customer, Output: (5) E16 Camlocks, 3-Pole, 5 Wire with weather cover ( L1 to L3 are female, neutral & ground are male) protected by (1) 125A 3-Pole disconnect switch.

##### SPECIFICATIONS

RATING	125, 120/208VAC, 3P+N+G
INPUT	Hard wire by customer Main Disconnect (1) 125A, 3-Pole switch
OUTPUT	(5) E16 Camlocks, 3P+N+G
DIMENSIONS	L 15.5" W 11.5" H 6.5"
WEIGHT	13 lbs.



4

5

### 649422CC5

#### CUSTOM PDU, 220A, 3-PH, 3-Pole, 5-Wire, UL Listed

##### DESCRIPTION

230/400VAC, Three Phase, four tier with Input: (5) E16 camlocks, 3-Pole, 5 Wire, Pass thru: (5) E16 camlocks, 3-Pole, 5 Wire, Output: (1) 63A IEC60309 IP67, 3-Pole, 5 Wire receptacle, (3) 32A IEC60309 IP67, 3-Pole, 5 Wire receptacles, (3) 32A IEC60309 IP67, 1-Pole, 3 Wire receptacles (5) 16A IEC60309 IP67, 1-Pole, 3 Wire receptacles protected by (6) 60A 3-Pole molded case circuit breakers, (3) 32A 3-Pole circuit breakers, (3) 32A 1-Pole circuit breakers, (5) 16A 1-Pole circuit breakers.

##### SPECIFICATIONS

RATING	220A, 230/400VAC, 3P+N+G
ENVIRONMENTAL RATING	NEMA 3R
INPUT	(5) E16 Camlocks, 3P+N+G
PASS THRU	(5) E16 Camlocks, 3P+N+G
OUTPUT	(1)63A IEC IP67, (3)32A IEC IP67 (3)32A IEC IP67, (5)16A IEC IP67
OVERCURRENT PROTECTION	(1) 60A 3-Pole, MCCB (3) 32A 3-Pole, MCB (3) 32A 1-Pole, MCB (5) 16A 1-Pole, MCB
DIMENSIONS	L 12" W 13" H 31"
WEIGHT	49 lbs.



6

7

8

9

10

**Emergency Services**

**649110CP24**

**Custom PDU, 100A, 1-PH, 2-Pole, 4-wire, UL Listed**

**DESCRIPTION**

120/208VAC, Single Phase single tier with Input: 100A 4100PS1W Plug, 2-Pole, 4 Wire with 10 feet of 4-AWG, 4 Conductor SOOW CORD, Output: (3) 50A CS TYPE, 2-Pole, 4 Wire receptacles with weather cover Protected by (3) 50A 2-Pole circuit breakers.

**SPECIFICATIONS**

RATING	100A, 120/208VAC, 2P+N+G
ENVIRONMENTAL RATING	NEMA 3R
INPUT	(1) 100A 4100PS1W Plug with 10 feet of 4/4 SOOW cable
OUTPUT	(3) 50A CS TYPE Receptacles 2P+N+G
OVERCURRENT PROTECTION	(3) 50A 2-Pole, MCB
DIMENSIONS	L 11.5" W 12.5" H 14"
WEIGHT	25 lbs.



**649112C35**

**CUSTOM PDU, 120A, 3-PH, 3-Pole, 5 Wire, UL Listed**

**DESCRIPTION**

120/208VAC, Three Phase single tier PDU with Input: (5) E16 Camlocks, 3-Pole, 5 Wire, Output: (2) 60A IEC60309 IP67, 3-Pole, 5 Wire receptacles protected by (2) 60A 3-Pole circuit breakers.

**SPECIFICATIONS**

RATING	120A, 120/208VAC, 3P+N+G
ENVIRONMENTAL RATING	NEMA 3R
INPUT	(5) E16 Camlocks, 3P+N+G
OUTPUT	(2) 60A IEC IP67, 3P+N+G
OVERCURRENT PROTECTION	(2) 60A 3-Pole, MCB
DIMENSIONS	L 11.5" W 12.5" H 14"
WEIGHT	19 lbs.



**649210I5**

**Custom PDU, 100A, 3-PH, 3-Pole, 5-Wire, UL Listed**

**DESCRIPTION**

120/208VAC, Three Phase double tier PDU with Input: (1) 100A IEC60309 IP67, 3-Pole, 5 Wire inlet, Output: (1) 50A CS Type, 3-Pole, 4 Wire receptacle with weather cover, (2) 30A NEMA L6-30R, 2-Pole 3 Wire receptacles with weather cover, (8) 20A Duplex, GFCI receptacles with weather cover Protected by (1) 50A 3-Pole Circuit breaker, (2) 30A 2-Pole circuit breakers, (8) 20A 1-Pole circuit breakers.

**SPECIFICATIONS**

RATING	100A, 120/208VAC, 3P+N+G
ENVIRONMENTAL RATING	NEMA 3R
INPUT	100A IEC IP67 Inlet, 3P+N+G
OUTPUT	(1) 50A CS Type, 3P+G; (2) 30A L6-30R, 2P+G (8) 20A Duplex GFCI
OVERCURRENT PROTECTION	(1) 50A 3-Pole, MCB; (2) 30A 2-Pole, MCB (8) 20A 1 Pole, MCB
DIMENSIONS	L 13" W 14" H 19"
WEIGHT	33 lbs.



### 649212CC3503

#### Custom PDU, 200A, 3-PH, 3-Pole, 5-Wire, UL Listed

##### DESCRIPTION

120/208VAC, Three Phase double tier with Input: (5) E16 Camlocks, 3-Pole, 5 Wire, Pass thru: (5) E16 Camlocks, 3-Pole, 5 Wire with weather cover, Output: (3) 100A IEC Pin and Sleeve# HBL4100RE1W, 2-Pole, 4 Wire Watertight receptacles, (2) 20A 5-20 Duplex with weather cover. Protected by (3) 100A 2-Pole circuit breakers, (2) 20A 1-Pole circuit breakers.

##### SPECIFICATIONS

<b>RATING</b>	200A, 120/208VAC, 3P+N+G
<b>ENVIRONMENTAL RATING</b>	NEMA 3R
<b>INPUT</b>	(5) E16 Camlocks, 3P+N+G
<b>PASS THRU</b>	(5) E16 Camlocks, 3P+N+G
<b>OUTPUT</b>	(3) 100A IEC REC.#; HBL4100RS1W, 2P+N+G (2) 20A 5-20 Duplex
<b>OVERCURRENT PROTECTION</b>	(3) 100A 2-Pole, MCB (2) 20A 1-Pole, MCB
<b>DIMENSIONS</b>	L 11.5" W 12.5" H 19"
<b>WEIGHT</b>	36 lbs.



1

2

3

### 649214C35

#### Custom PDU, 140A, 3-PH, 3-Pole, 5-Wire, UL Listed

##### DESCRIPTION

120/208VAC, Three Phase double tier with Input: (5) E16 Camlocks, 3-Pole 5 Wire, Output: (2) 50A CS Type, 3-Pole, 4 Wire receptacles with weather cover, (1) 30A Twist lock, NEMA L6-30R, 2-Pole, 4 Wire receptacle with weather cover, (2) 20A Duplex, NEMA 5-20R with weather cover protected by (2) 50A 3-Pole circuit breakers, (1) 30A 2-Pole circuit breaker, (2) 20A 1-Pole circuit breakers.

##### SPECIFICATIONS

<b>RATING</b>	140A, 120/208VAC, 3P+N+G
<b>ENVIRONMENTAL RATING</b>	NEMA 3R
<b>INPUT</b>	(5) E16 Camlocks, 3P+N+G
<b>OUTPUT</b>	(2) 50A CS TYPE, 3P+G; (1) 30A L6-30R, 2P+N+G (2) 20A 5-20 Duplex
<b>OVERCURRENT PROTECTION</b>	(2) 50A 3-Pole, MCB; (1) 30A 2-Pole, MCB (2) 20A 1-Pole, MCB
<b>DIMENSIONS</b>	L 11.5" W 12.5" H 19"
<b>WEIGHT</b>	36 lbs.



4

5

6

### 649215C35

#### Custom PDU, 150A, 3-PH, 3-Pole, 5-Wire, UL Listed

##### DESCRIPTION

120/208VAC, Three Phase double tier with Input: (5) E16 Camlocks, 3-Pole, 5 Wire, Pass thru: (5) E16 Camlocks, 3-Pole 5 Wire, Output: (1) 100A IEC, M4100R12, 2-Pole, 4-Wire receptacle, (2) 50A CS Type, 2-Pole 4-wire receptacles with weather cover, (1) 20A Duplex 5-20R with weather cover protected by (1) 100A 2-Pole circuit breaker, (2) 50A 2-Pole circuit breakers, (1) 20A 1-Pole circuit breaker.

##### SPECIFICATIONS

<b>RATING</b>	150A, 120/208VAC, 3P+N+G
<b>ENVIRONMENTAL RATING</b>	NEMA 3R
<b>INPUT</b>	(5) E16 Camlocks, 3P+N+G
<b>PASS THRU</b>	(5) E16 Camlocks, 3P+N+G
<b>OUTPUT</b>	(1) 100A IEC, M4100R12; (2) 50A CS Type, 2P+N+G (1) 20A 5-20 Duplex
<b>OVERCURRENT PROTECTION</b>	(1) 100A 2-Pole, MCB, (2) 50A 2-Pole, MCB (1) 20A 1-Pole, MCB
<b>DIMENSIONS</b>	L 12" W 15" H 19"
<b>WEIGHT</b>	39 lbs.



7

8

9

10



## Emergency Services

### 649225C35

#### Custom PDU, 220A, 3-PH, 3-Pole, 5 Wire, UL Listed

##### DESCRIPTION

120/208VAC, Three Phase double tier PDU with Input: (5) E16 Camlocks, 3-Pole, 5 Wire, Output: (2) 100A IEC, M4100R12, 2-Pole, 4 Wire receptacles, (2) 50A CS Type, 2-Pole, 4 Wire receptacles with weather cover, (1) 20A Duplex 5-20R with weather cover protected by (2) 100A 2-Pole circuit breakers, (2) 50A 2-Pole circuit breakers, (1) 20A 1-Pole circuit breakers.

##### SPECIFICATIONS

<b>RATING</b>	220A, 120/208VAC, 3P+N+G
<b>ENVIRONMENTAL RATING</b>	NEMA 3R
<b>INPUT</b>	(5) E16 Camlocks, 3P+N+G
<b>OUTPUT</b>	(2) 100A IEC, M4100R12 (2) 50A CS Type, 2P+N+G (1) 20A 5-20 Duplex
<b>OVERCURRENT PROTECTION</b>	(2) 100A 2-Pole, MCB (2) 50A 2-Pole, MCB (1) 20A 1-Pole, MCB
<b>DIMENSIONS</b>	L 12" W 16" H 19"
<b>WEIGHT</b>	39 lbs.





**HEB201U**

**CUSTOM PDU 50A, 1-PH, 2-Pole, 4 Wire, UL Listed**

**DESCRIPTION**

120/208VAC, Single Phase one tier PDU with Input: (1) 50A Twist lock CS6375 2-Pole, 4 Wire inlet, Output: (1) 50A Twist lock, CS6369, 2-Pole, 4 Wire receptacle with weather cover, (6) 20A Duplex GFCI receptacles protected by (1) 50A 2-Pole breaker(main), (6) 20A 1-Pole breakers.

**SPECIFICATIONS**

RATING	50A, 120/208VAC, 2P+N+G
ENVIRONMENTAL RATING	NEMA 3R
INPUT	(1) 50A CS Type 2P+N+G Inlet
OUTPUT	(1) 50A CS Type 2P+N+G Rec. (6) 20A Duplex GFCI
OVERCURRENT PROTECTION	(1) 50A 2-Pole, MCB (6) 20A 1-Pole, MCB
DIMENSIONS	L 11.5" W 12.5" H 14"
WEIGHT	19 lbs.



- 1
- 2
- 3
- 4
- 5
- 6
- 7
- 8
- 9
- 10

## Alternate Energy, Wind, Solar and Mining

### 649102TXF13

#### CUSTOM PDU, 10A, 1-PH, 1-Pole, 3-Wire

##### DESCRIPTION

500-VA Single Phase step down transformer, 120V Primary, 12V-40A Secondary inside single tier PDU with Input: (1) 10A of 8 feet, 14-AWG, 3 Conductor, SOOW cord, Output: (4) 12 VAC Receptacles with weather cover protected by (1) 8A Single Pole breaker.

##### SPECIFICATIONS

RATING	10A, 120/12VAC, 1P+N+G
ENVIRONMENTAL RATING	NEMA 3R
INPUT	10A Of 8-ft, 14/3 SO. Cord to 500-VA transformer
OUTPUT	(4) 12-VAC REC., 1P+N+G
DIMENSIONS	L 11" W 12" H 14"
WEIGHT	28 lbs.



### 649106PC3501

#### CUSTOM PDU, 60A, 3-PH, 3-Pole, 5-Wire, UL Listed

##### DESCRIPTION

120/208VAC, Three Phase single tier PDU with Input: (1) 60A IEC60309 IP44, 3-Pole, 5 Wire Plug with 3-feet of 8-AWG, 5 Conductor type W cable, Output: (3) 30A Twist lock, L14-30R, 2-Pole, 4 Wire receptacles protected by (3) 30A 2-Pole circuit breakers.

##### SPECIFICATIONS

RATING	60A, 120/208VAC, 3P+N+G
ENVIRONMENTAL RATING	NEMA 3R
INPUT	(1) 60A IEC IP44, 3P+N+G Plug with 3FT, 8/5C Type W cable
OUTPUT	(3) 30A L14-30R, 2P+N+G Rec.
OVERCURRENT PROTECTION	(3) 30A 2-Pole, MCB
DIMENSIONS	L 11.5" W 12.5" H 14"
WEIGHT	21 lbs.



### 649106PC3502

#### CUSTOM PDU, 40A, 3-PH, 3-Pole, 5 Wire, UL Listed

##### DESCRIPTION

120/208VAC, Three Phase single tier PDU with Input: (1) 60A IEC60309 IP44, 3-Pole, 5 Wire Plug with 3 feet of 8 AWG, 5 Conductor cable, Output: (6) 20A Duplex GFCI receptacles protected by (6) 20A 1-Pole circuit breakers.

##### SPECIFICATIONS

RATING	40A, 120/208VAC, 3P+N+G
ENVIRONMENTAL RATING	NEMA 3R
INPUT	(1) 60A IEC IP44, 3P+N+G Plug with 3FT, 8/5C Type W cable
OUTPUT	(6) 20A Duplex GFCI, Rec.
OVERCURRENT PROTECTION	(6) 20A 1-Pole, MCB
DIMENSIONS	L 11.5" W 12.5" H 14"
WEIGHT	21 lbs.



1

2

3

### 682103CB

#### CUSTOM PDU 20A, 1-PH, 2-Pole, 4-Wire

##### DESCRIPTION

5 KVA Single Phase step down transformer, 690V Primary, 120/240 Secondary voltage, Input: (1) 30A IEC60309 IP67, 2-Pole, 4 Wire plug with 7FT of plastic conduit, Output: (2) 20A 5-20 Duplex receptacles protected by (2) 20A 1-Pole circuit breakers.

##### SPECIFICATIONS

RATING	7.2A/690~ 1PH 20A /120-240V~1PH
ENVIRONMENTAL RATING	NEMA 3R
INPUT	(1) 30A IEC60309 IP67, 3P+G plug with 7FT of plastic conduit
OUTPUT	(2) 20A 5-20 Duplex
OVERCURRENT PROTECTION	(2) 20A 1-Pole, MCB
DIMENSIONS	L 19" W 12" H 22"
WEIGHT	125 lbs.



4

5

6

7

8

9

10

## Military & Satellite Communications

### 649106CC

#### CUSTOM PDU 60A, 3-PH, 3-Pole, 4-Wire, UL Listed

##### DESCRIPTION

600VAC, Three Phase single tier with Input: (4) E15 Mini camlocks, 3-Pole, 4 Wire with 6 feet of 4 AWG 4 Conductor SOOW cable, Output: (2) 30A Arktite 431, 3-Pole, 4 Wire receptacles protected by (2) 30A 3 Pole circuit breakers.

##### SPECIFICATIONS

RATING	60A, 600VAC, 3P+G
ENVIRONMENTAL RATING	NEMA 3R
INPUT	(4) E15 Mini camlocks, 3P+G
OUTPUT	(2) 30A AR431 3P+G
OVERCURRENT PROTECTION	(2) 30A 3 Pole, MCB
DIMENSIONS	L 11.5" W 12.5" H 14"
WEIGHT	20 lbs.



### HEB361U

#### “Off-the-Shelf” PDU, 40A, 3-PH, 3-Pole, 5-Wire, UL Listed

##### DESCRIPTION

120/208VAC, Three Phase one tier PDU with Input: (1) 60A IEC60309 IP67, 3-Pole, 5 Wire inlet, Output: (6) 20A NEMA 5-20 Duplex receptacles with weather cover protected by (6) 20A 1-Pole circuit breakers.

##### SPECIFICATIONS

RATING	40A, 120/208VAC, 3P+N+G
ENVIRONMENTAL RATING	NEMA 3R
INPUT	(1) 60A IEC60309 IP67, 3P+N+G Inlet
OUTPUT	(6) 20A 5-20R Duplex Rec.
OVERCURRENT PROTECTION	(6) 20A 1-Pole, MCB
DIMENSIONS	L 11.5" W 12.5" H 14"
WEIGHT	19 lbs.



**HEB3103U**

**“Off-the-Shelf” PDU, 80A, 3-PH, 3-Pole, 5-Wire, UL Listed**

**DESCRIPTION**

120/208VAC, Three Phase one tier PDU with Input: (5) E16 Camlocks, 3-Pole, 5 Wire, Output: (2) 30A Twist lock, NEMA L21-30R, 3-Pole, 5 Wire receptacles, (3) 20A 5-20 Duplex receptacles protected by (2) 3-Pole circuit breaker, (3) 20A 1-Pole circuit breakers.

**SPECIFICATIONS**

RATING	80A, 120/208VAC, 3P+N+G
ENVIRONMENTAL RATING	Indoor use
INPUT	(5) E16 Camlocks, 3P+N+G
OUTPUT	(2) 30A L21-30R Rec. (3) 20A 5-20 Duplex Rec.
OVERCURRENT PROTECTION	(2) 30A 3-Pole, MCB (3) 20A 1-Pole, MCB
DIMENSIONS	L 11.5” W 12.5” H 14”
WEIGHT	19 lbs.



- 1
- 2
- 3

**HEB3107AU**

**Custom PDU, 100A, 3-PH, 3-Pole, 5-Wire, UL Listed**

**DESCRIPTION**

120/208VAC, Three Phase double tier PDU with Input: of (5) E16 Camlocks, 3-Pole, 5 Wire, Output: (14) 20A, NEMA 5-20 Duplex, 1-Pole, 3 Wire receptacles with weather cover protected by (14) 20A 1-Pole circuit breaker.

**SPECIFICATIONS**

RATING	100A, 120/208VAC, 3P+N+G
ENVIRONMENTAL RATING	NEMA 3R
INPUT	(5) E16 Camlocks, 3P+N+G
OUTPUT	(14) 20A, 5-20 Duplex Receptacle
OVERCURRENT PROTECTION	(14) 20A 1-Pole, MCB
DIMENSIONS	L 11.5” W 12.5” H 19”
WEIGHT	35 lbs.



- 4
- 5
- 6
- 7

- 8
- 9

- 10



## Military & Satellite Communications

### 649206U

#### Custom PDU, 60A, 1-PH, 2-Pole, 3-Wire, UL Listed

##### DESCRIPTION

250VAC, Three Phase double tier with Input: (1) IEC60309 IP67, 2-Pole, 3 Wire inlet, Output: (4) 30A IEC60309 IP44, 2-Pole, 3 Wire receptacles, (4) 16A IEC60309 IP44, 2-Pole 3 Wire Protected by (1) 63A, 100ma, 2-Pole, F200, RCD breaker (main), (4) 16A 2-Pole circuit breaker, (4) 30A 2-Pole circuit breaker.

##### SPECIFICATIONS

RATING	60A, 250VAC, 2P+G
ENVIRONMENTAL RATING	NEMA 3R
INPUT	(1) 60A IEC IP67, 2P+G Inlet
OUTPUT	(4) 30A IEC IP44, 2P+G Rec. (4) 16A IEC IP44, 2P+G Rec.
OVERCURRENT PROTECTION	(1) 63A, 100ma, 2-Pole, F200, RCD (4) 30A 2-Pole, MCB; (4) 16A 2-Pole, MCB
DIMENSIONS	L 11.5" W 12.5" H 19"
WEIGHT	32 lbs.



### HEB201BU

#### Custom PDU 50A, 1-PH, 2-Pole, 4 Wire, UL Listed

##### DESCRIPTION

120/208VAC, Single Phase one tier PDU with Input: (1) 50A Twist lock CS6375 2-Pole, 4 Wire inlet, Output: (1) 50A Twist lock, CS6369, 2-Pole, 4 Wire receptacle with weather cover, (6) 20A 5-20 Duplex receptacles protected by (1) 50A 2-Pole breaker(main), (6) 20A 1-Pole breakers.

##### SPECIFICATIONS

RATING	50A, 120/208VAC, 2P+N+G
ENVIRONMENTAL RATING	Indoor use
INPUT	(1) 50A CS Type 2P+N+G Inlet
OUTPUT	(1) 50A CS Type 2P+N+G Rec. (6) 20A 5-20 Duplex
OVERCURRENT PROTECTION	(1) 50A 2-Pole, MCB (6) 20A 1-Pole, MCB
DIMENSIONS	L 11.5" W 12.5" H 14"
WEIGHT	19 lbs.



### HEB201L

#### “Off-the-Shelf” PDU, 50A, 1-PH, 2-Pole, 4-Wire, UL Listed

##### DESCRIPTION

120/208VAC, Single Phase one tier PDU with Input: (1) 50A Twist lock, CS6375, 2-Pole, 4 Wire inlet, Output: (6) 20A Duplex GFCI receptacles with weather cover protected by (6) 20A 1-Pole circuit breakers.

##### SPECIFICATIONS

RATING	50A, 120/208VAC, 2P+N+G
ENVIRONMENTAL RATING	NEMA 3R
INPUT	(1) 50A CS Type, 2P+N+G
OUTPUT	(6) 20A Duplex GFCI
OVERCURRENT PROTECTION	(6) 20A 1-Pole, MCB
DIMENSIONS	L 11.5" W 12.5" H 14"
WEIGHT	19 lbs.



**HEB202U**

**“Off-the-Shelf” PDU, 50A, 1-PH, 2-Pole, 4-Wire, UL Listed**

**DESCRIPTION**

120/208VAC, Single Phase one tier PDU with Input: (1) 50A Twist lock, CS6375, 2-Pole, 4 Wire inlet, Output: (1) 50A Twist lock, CS6369 2-Pole, 4 Wire receptacle, (1) 30A Twist lock, L6-30R, 2-Pole, 3 Wire receptacles, (3) 20A Duplex GFCI receptacles protected by (1) 50A 2-Pole circuit breaker, (1) 30A 2-Pole circuit breakers, (3) 20A 1-Pole circuit breakers.

**SPECIFICATIONS**

RATING	50A, 120/208VAC, 2P+N+G
ENVIRONMENTAL RATING	NEMA 3R
INPUT	(1) 50A CS Type 2P+N+G Inlet
OUTPUT	(1) 50A CS Type 2P+N+G Rec. (6) 20A 5-20 Duplex
OVERCURRENT PROTECTION	(1) 50A 2-Pole, MCB (6) 20A 1-Pole, MCB
DIMENSIONS	L 11.5” W 12.5” H 14”
WEIGHT	19 lbs.



- 1
- 2
- 3

**HEB203U**

**“Off-the-Shelf” PDU, 50A, 1-PH, 2-Pole, 4-Wire, UL Listed**

**DESCRIPTION**

120/208VAC, Single Phase one tier PDU with Input: (1) 50A Twist lock, CS6375, 2-Pole, 4 Wire inlet, Output: (1) 50A Twist lock, CS6369 2-Pole, 4 Wire receptacle, (2) 30A Twist lock, L6-30R, 2-Pole, 3 Wire receptacles, (3) 20A Duplex GFCI receptacles protected by (1) 50A 2-Pole circuit breaker, (2) 30A 2-Pole circuit breakers, (3) 20A 1-Pole circuit breakers.

**SPECIFICATIONS**

RATING	50A, 120/208VAC, 2P+N+G
ENVIRONMENTAL RATING	NEMA 3R
INPUT	(1) 50A CS Type, 2P+N+G Inlet
OUTPUT	(1) 50A CS Type, 2P+N+G Rec. (2) 30A L6-20R, 2P+G Rec. (3) 20A Duplex GFCI
OVERCURRENT PROTECTION	(1) 50A 2-Pole, MCB (Main) (2) 30A 2-Pole, MCB (3) 20A 1-Pole, MCB
DIMENSIONS	L 11.5” W 12.5” H 14”
WEIGHT	19 lbs.



- 4
- 5
- 6
- 7

- 8

- 9

- 10

## Portable Power Distribution with Transformers

### 682104TSPWU

#### CUSTOM PDU, 30A, 1-PH, 2-Pole, 4-Wire, UL Listed

##### DESCRIPTION

7.5 KVA Single Phase step down transformer, 480V Primary, 120/240 Secondary voltage, Input: (1) 30A IEC60309 IP67, 3-Pole, 4 Wire inlet, Output: (2) 20A 5-20 Duplex, GFCI receptacles protected by (1) 30A 2-Pole circuit breaker, (1) 50A 2-Pole circuit breaker, (4) 20A 1-Pole circuit breakers.

##### SPECIFICATIONS

RATING	30A, 480-120/240VAC, 3P+G
ENVIRONMENTAL RATING	NEMA 3R
INPUT	(1) 30A IEC60309 IP67, 3P+G Inlet
OUTPUT	(4) 20A Duplex, GFCI
OVERCURRENT PROTECTION	(1) 30A 2-Pole, MCB (1) 50A 2-Pole, MCB (4) 20A 1-Pole, MCB
DIMENSIONS	L 16" W 18" H 46"
WEIGHT	125 lbs.



### 682103TSPWU

#### CUSTOM PDU, 30A, 3-PH, 3-Pole, 4-Wire, UL Listed

##### Description

7.5 KVA Single Phase step down transformer, 480V Primary, 120/240 Secondary voltage, Three phase, Input: (1) 30A IEC60309 IP67, 3-Pole, 4 Wire inlet, Output: (1) 20A, 480V IEC60309 IP67, 3-Pole, 4 Wire receptacle, (2) 20A 5-20 Duplex receptacles protected by (1) 20A 3-Pole circuit breaker, (1) 30A 2-Pole circuit breaker, (1) 20A 2-Pole circuit breaker, (2) 20A 1-Pole circuit breakers.

##### SPECIFICATIONS

RATING	30A, 480/120VAC, 3P+G
ENVIRONMENTAL RATING	NEMA 3R
INPUT	(1) 30A IEC IP67, 3P+G Inlet
OUTPUT	(1) 20A IEC IP67, 3P+G (2) 20A 5-20 Duplex
OVERCURRENT PROTECTION	(1) 20A 3-Pole, MCB (1) 30A 2-Pole, MCB (1) 20A 2-Pole, MCB, (2) 20A 1-Pole, MCB
DIMENSIONS	L 16" W 18" H 46"
WEIGHT	125 lbs.



NOTE: Color of Handtruck may vary

### 682103CB

#### CUSTOM PDU, 40A, 1-PH, 2-Pole, 4-Wire, UL Listed

##### DESCRIPTION

5 KVA Single Phase step down transformer, 690V Primary, 120/240 Secondary voltage, Input: (1) 30A IEC60309 IP67, 2-Pole, 4 Wire plug with 7FT of plastic conduit, Output: (2) 20A 5-20 Duplex receptacles protected by (2) 20A 1-Pole circuit breakers.

##### SPECIFICATIONS

RATING	40A, 690-120/240VAC
ENVIRONMENTAL RATING	NEMA 3R
INPUT	(1) 30A IEC60309 IP67, 3P+G plug with 7FT of plastic conduit
OUTPUT	(2) 20A 5-20 Duplex
OVERCURRENT PROTECTION	(2) 20A 1-Pole, MCB
DIMENSIONS	L 19" W 12" H 22"
WEIGHT	125 lbs.



1

2

3

4

5

6

7

8

9

10













Scan QR Code to download one of our industrial electrical catalogs -or- visit [www.waltherelectric.com/downloads/catalogs-brochures/](http://www.waltherelectric.com/downloads/catalogs-brochures/)



**F. Walther Electric Corporation**

12 World's Fair Drive  
Somerset NJ, 08873 USA

+1 (800) 925-8437 toll free  
+1 (732) 537-9201 phone  
+1 (732) 537-9209 fax

[custserv@waltherelectric.com](mailto:custserv@waltherelectric.com)  
[www.waltherelectric.com](http://www.waltherelectric.com)

rev. 2303