

## PRODUCT DATA SHEET

Part Number 379419

EAN

Manufacturer Walther-Werke

WEEE-Reg-Nr: DE 22131895

### 100-A IEC 60309 Coupler, 3-PH, 4 Wire

- High impact thermoplastic housing featuring high resistance And toughness creating an abrasion-resistant material
- Cable gland with “onion ring” neoprene bushing
- Retaining device
- Internal strain relief with “swing-away” feature
- Locking ring and gasket
- Zinc electroplated steel screws
- Shrouded pins
- Double terminal screws on all amperage devices
- Ground first to mate – last to break for added safety
- Walther can produce and supply the mating cable assemblies.



### Ordering/Logistics Information

Order Unit	Piece
Customs Number	
Net Weight	3.24 lbs or 1.47 kg
Packing Quantity (VPE)	2
Packaging Length	15.36 in or 0.39 m
Packaging Width	7.50 in or 0.19 m
Packaging Depth	7.10 in or 0.18 m
Gross Weight (VPE)	6.95 lbs or 3.15 kg

### Conformities

CE Conformity

RoHS directive

RoHS directive

REACH regulation

## Certification

VDE certification	123028
UL certification	E329476 
And multiple international certifications	

## Technical Product Data

IEC-amperage	125 A
Amperage according to UL/CSA (for UL-version)	100 A
Number of poles and wires	3P + G
Voltage according to EN 60309-2	480 V (50+60 Hz)
Clock hour position	7 h
Identification color	Red
Conductor cross-section	6 – 1 AWG or 16 - 50 mm <sup>2</sup>
Cable diameter	0.94 – 1.78 in or 24 - 45 mm
Cable strip length	3.15 in +/- 0.2 in or 80 mm +/- 5 mm
Cable ferrules length	1.06 in +/- 0.04 in or 27 mm +/- 1 mm
Maximum torque terminal screw	3.5-4 Nm
Maximum torque back shell	2 Nm
Degree of protection (IP)	IP67
Connection system	Screwed terminal
Contact material	Nickel-plated brass
Cable entry	Swivel
Angle of plug	Straight
Material	Plastic
Inflammability class of insulation material according to with UL94	V2

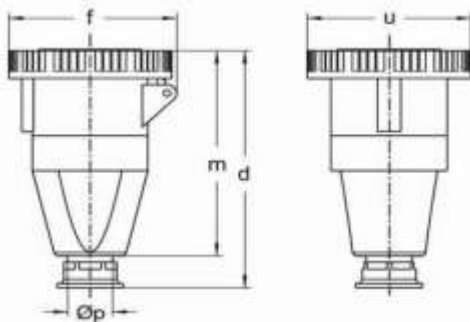

Amp.	20	60			100		
Pole	3	3	4	5	3	4	5
d	136	255	255	255	332	332	332
f	78	117	117	117	130	130	130
m	121	206	206	206	275	275	275
u	72	110	110	110	130	130	130
Øp	7,5-14,5	18-34,5	18-34,5	18-34,5	24-45	24-45	24-45

All specifications are subject to change without notice. Consult a Walther Electric Engineer for the latest specifications or speak with a member of our Customer Care Team +1 (800) 925-8437.