

PRODUCT DATA SHEET

Part Number 678319

EAN

Manufacturer Walther-Werke

WEEE-Reg-Nr

100A IEC 60309 Surface mount inlet, 1-PH, 3 WIRE

- 1x M50 or (1.97 inches) and 1xM20 or (0.79 inches) intop cable entries with 2xM40 or (1.57 inches) bottom cable entries
- Terminal set 3x50qmm or (1/0 AWG)
- High Impact Thermoplastic featuring high resistance
- And toughness creating an abrasion-resistant material
- Zinc electroplated Steel Screws
- Color Coded by voltage
- Double terminal screws on all amperage devices
- Ground first to mate – last to break for added safety
- Walther can custom design configurations that meet your application requirements.
- Walther can produce and supply the mating cable assemblies.



Ordering/Logistics Information

Order Unit	Piece
Net Weight	5.95 lbs or 2.7 kg
Packing Quantity (VPE)	1
Packaging Length	16.06 in or 0.408 m
Packaging Width	9.45 in or 0.24 m
Packaging Depth	7.32 or 0.186 m
Gross Weight (VPE)	6.69 lbs or 2.99 kg

Certification

VDE/ENEC certification	123030
EAC certification	BY112.02.01.020 06091
And multiple international certifications	

Classification system

Classification system	ETIM_6.0
ETIM Class	EC001319

Technical Product Data

IEC-amperage	125A
Amperage acc. UL/CSA	100A
Number of poles	2P + G
Voltage acc. EN 60309-2	480 V / (50-60HZ)
Clock hour position	7 h
Identification color	Red
RAL-number	3000
Degree of protection (IP)	IP67
Connection system	Screwed terminal
Maximum torque terminal screw	4 Nm
Angle of receptacle	Angles
Material	Plastic
Connection type	Wall mount plug

Dimension sheet

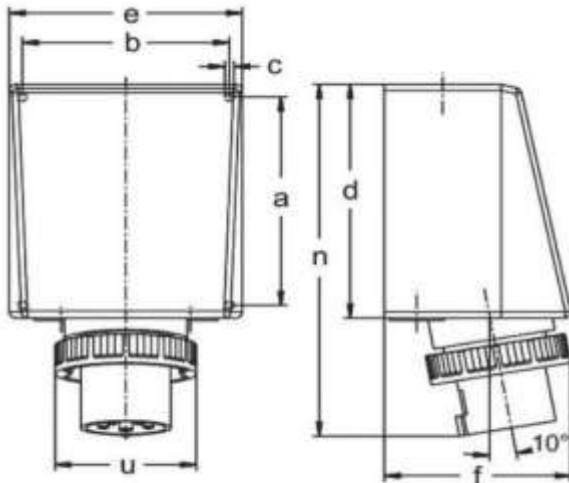

Amp.	125		
Pole	3	4	5
a	240	240	240
b	200	200	200
c	7	7	7
d	263	263	263
e	220	220	220
f	175	175	175
n	390	390	390
u	130	130	130
M1	50/20	50/20	50/20
M2	40	40	40

All specifications are subject to change without notice. Consult a Walthers Electric Engineer for the latest specifications or speak with a member of our Customer Care Team +1 (800) 925-8437.