

PRODUCT DATA SHEET

Part Number 379407

EAN

Manufacturer Walther-Werke

WEEE-Reg-Nr: DE 22131895

100-A IEC 60309 Coupler, 3-PH, 4 Wire

- High impact thermoplastic housing featuring high resistance And toughness creating an abrasion-resistant material
- Cable gland with “onion ring” neoprene bushing
- Retaining device
- Internal strain relief with “swing-away” feature
- Locking ring and gasket
- Zinc electroplated steel screws
- Shrouded pins
- Double terminal screws on all amperage devices
- Ground first to mate – last to break for added safety
- Walther can produce and supply the mating cable assemblies.



Ordering/Logistics Information

Order Unit	Piece
Customs Number	
Net Weight	3.24 lbs or 1.47 kg
Packing Quantity (VPE)	2
Packaging Length	15.36 in or 0.39 m
Packaging Width	7.50 in or 0.19 m
Packaging Depth	7.10 in or 0.18 m
Gross Weight (VPE)	6.95 lbs or 3.15 kg

Conformities

CE Conformity

RoHS directive

RoHS directive

REACH regulation

Certification

VDE certification	123028
UL certification	E329476 
And multiple international certifications	

Technical Product Data

IEC-amperage	125 A
Amperage according to UL/CSA (for UL-version)	100 A
Number of poles and wires	3P + G
Voltage according to EN 60309-2	500 V (50+60 Hz)
Clock hour position	7 h
Identification color	Black
Conductor cross-section	6 – 1 AWG or 16 - 50 mm ²
Cable diameter	0.94 – 1.78 in or 24 - 45 mm
Cable strip length	3.15 in +/- 0.2 in or 80 mm +/- 5 mm
Cable ferrules length	1.06 in +/- 0.04 in or 27 mm +/- 1 mm
Maximum torque terminal screw	3.5-4 Nm
Maximum torque back shell	2 Nm
Degree of protection (IP)	IP67
Connection system	Screwed terminal
Contact material	Nickel-plated brass
Cable entry	Swivel
Angle of plug	Straight
Material	Plastic
Inflammability class of insulation material according to with UL94	V2

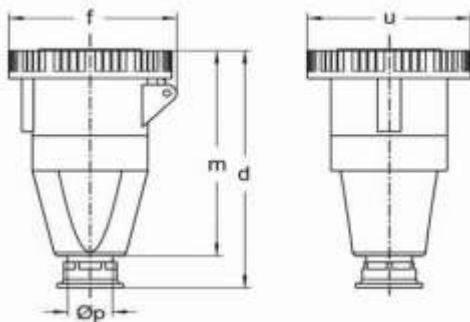

Amp.	20	60			100		
Pole	3	3	4	5	3	4	5
d	136	255	255	255	332	332	332
f	78	117	117	117	130	130	130
m	121	206	206	206	275	275	275
u	72	110	110	110	130	130	130
Øp	7,5-14,5	18-34,5	18-34,5	18-34,5	24-45	24-45	24-45

All specifications are subject to change without notice. Consult a Walther Electric Engineer for the latest specifications or speak with a member of our Customer Care Team +1 (800) 925-8437.