

PRODUCT DATA SHEET

Part Number	479409
EAN	4015609020720
Manufacturer	Walther-Werke
WEEE-Reg-Nr	DE 221331895

125A 4P 230V 9H IP67 IEC Receptacle

- High Impact Thermoplastic featuring high resistance And toughness creating an abrasion-resistant material
- Retaining Device
- Gasket
- Zinc electroplated Steel Screws
- Color Coded by voltage
- Double terminal screws on all amperage devices
- Ground first to mate – last to break for added safety
- Finger-safe in accordance with BGV A3 soft transition radius from flange to collar
- Walther can custom design configurations that meet your application requirements.
- Walther can produce and supply the mating cable assemblies.



Ordering/Logistics Information

Order Unit	Piece
Net Weight	2.55 lbs or 1.155 kg
Packing Quantity (VPE)	2
Packaging Length	12.21 in or 0.31 m
Packaging Width	7.68 in or 0.195 m
Packaging Depth	5.52 in or 0.14 m
Gross Weight (VPE)	5.41 lbs or 2.458 kg

Certification

VDE/ENEC certification	123029
UL certification	E83342 
EAC certification	BY112.02.01.020 03089
And multiple international certifications	

Classification system

Classification system	ETIM_6.0
ETIM Class	EC001317

Technical Product Data

IEC-amperage	125A
Amperage acc. UL/CSA	100A
Number of poles	4 = 3P + G
Voltage acc. EN 60309-2	230 V / (50-60HZ)
Clock hour position	9 h
Identification color	Blue
RAL-number	5002
Degree of protection (IP)	IP67
Connection system	Screwed terminal
Maximum torque terminal screw	4 Nm
Angle of receptacle	Straight
Material	Plastic
Flange size horizontal	4.49 in or 114 mm
Drill hole distance vertical	3.55 in or 90 mm
Flange size horizontal	4.49 in or 114 mm
Drill hole distance horizontal	3.55 in or 90 mm

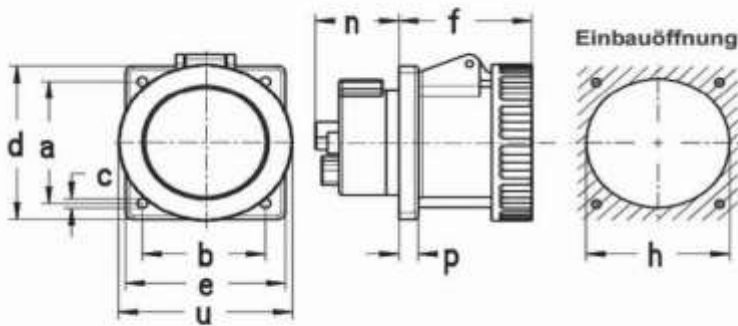

Amp.	100		
Pole	3	4	5
a	90	90	90
b	90	90	90
c	6,5	6,5	6,5
d	114	114	114
e	114	114	114
f	96	96	96
h	90	90	90
n	64	64	64
p	12	12	12
u	130	130	130

All specifications are subject to change without notice. Consult a Walther Electric Engineer for the latest specifications or speak with a member of our Customer Care Team +1 (800) 925-8437.